

iSG18GFP User Manual, General, Section G

iSG18GFP

Intelligent 18 Port Compact Service Aware Ethernet Switch
IEC 61850-3 and IEEE 1613 Compliant



Version 4.5.06.3, Mar 2023



SERVICES • SUPPORT • SECURITY • SOLUTIONS • SYSTEMS

© 2023 iS5 Communications Inc. All rights reserved.

COPYRIGHT NOTICE

© 2023 iS5 Communications Inc. All rights reserved.

No part of this publication may be reproduced in any form without the prior written consent of iS5 Communications Inc. (iS5).

TRADEMARKS

iS5Com is a registered trademark of iS5. All other trademarks belong to their respective owners.

REGULATORY COMPLIANCE STATEMENT

Product(s) associated with this publication complies/comply with all applicable regulations. For more details, refer to the Technical Specifications.

WARRANTY

iS5 warrants that all products are free from defects in material and workmanship for a specified warranty period from the invoice date (5 years for most products). iS5 will repair or replace products found to be defective within this warranty period including shipping costs. This warranty does not cover product modifications or repairs done by persons other than iS5-approved personnel, and this warranty does not apply to products that are misused, abused, improperly installed, or damaged by accident.

Refer to the Technical Specifications for the actual warranty period(s) of the product(s) associated with this publication.

DISCLAIMER

Information in this publication is intended to be accurate. iS5 shall not be responsible for its use or infringements on third-parties because of the use of this publication. There may occasionally be unintentional errors on this publication. iS5 reserves the right to revise the contents of this publication without notice.

CONTACT INFORMATION

iS5 Communications Inc

5895 Ambler Dr., Mississauga, Ontario, L4W 5B7

Tel: 1+ 905-670-0004

Website: <http://www.is5com.com/>

Technical Support

E-mail: support@is5com.com

Sales Contact

E-mail: info@is5com.com

Table of Contents

| | | |
|-------------------|--|-------------------------------------|
| CHAPTER 1: | ABOUT THE DOCUMENT | 8 |
| | 1.1 iSG18GFP Overview..... | 8 |
| | 1.2 Using this Document | 8 |
| | 1.2.1 Documentation Purpose | 8 |
| | 1.2.2 Intended Audience | 9 |
| | 1.2.3 Documentation Suite..... | 9 |
| | 1.2.4 Conventions Used..... | 10 |
| | List of Abbreviations | 11 |
| | 1.3 References | 11 |
| CHAPTER 2: | HARDWARE AND INTERFACES..... | 12 |
| | 2.1 Graphical View of Hardware | 12 |
| | 2.2 Logical System View..... | 12 |
| CHAPTER 3: | INSTALLATION | 13 |
| | 3.1 Distance Kept for Natural Air Flow..... | 13 |
| | 3.2 Grounding | 13 |
| | 3.3 Connecting to a Power Source..... | 14 |
| | 3.3.1 Wiring DC Input Voltage Feed..... | 14 |
| | 3.3.2 Wiring AC Input Voltage Connector | 15 |
| | 3.3.3 Power Budget | 15 |
| CHAPTER 4: | CONFIGURATION ENVIRONMENT..... | 16 |
| | 4.1 Command Line Interface | 16 |
| | 4.2 Command Line navigation | 17 |
| | 4.2.1 Minimum Abbreviation | 17 |
| | 4.2.2 GREP | 17 |
| | 4.2.3 Dynamic Completion of Commands | 18 |
| | 4.2.4 Help (?) | 18 |
| | 4.2.5 Keyboard Shortcuts | 18 |
| | 4.3 Supported Functionalities..... | 19 |
| | 4.4 System Defaults | 21 |
| | 4.5 Root Commands | 22 |
| | 4.6 Root Commands Description | 23 |
| | 4.7 GCE Commands..... | 24 |
| | 4.8 GCE Commands Description..... | 27 |
| | 4.9 ACE Commands | 31 |
| | 4.10 Main Show Commands..... | 32 |
| | 4.10.1 GCE | 32 |
| | 4.10.2 ACE..... | 33 |
| CHAPTER 5: | SYSTEM VERSION AND DATABASE..... | 36 |
| | 5.1 Configuration Database | Error! Bookmark not defined. |
| | 5.1.1 OS Version..... | 36 |
| | 5.2 Running Configuration | 36 |
| | 5.3 Commands Hierarchy..... | 36 |
| | 5.4 Upgrading the OS..... | 38 |
| | 5.4.1 From USB | 38 |
| | 5.4.2 From SFTP | 39 |
| | 5.5 Example of Exporting DB and Logs..... | 41 |
| | 5.6 Example of Exporting DB Files to Flash Drive..... | 41 |
| | 5.7 Example of Importing DB from TFTP | 41 |

| | | | |
|-------------------|-------------|---|-----------|
| | 5.8 | Safe Mode | 42 |
| | 5.8.1 | OS Image Upgrade and Recovery | 44 |
| | 5.8.2 | Uploading OS Image Update from USB | 45 |
| | 5.8.3 | Installing First Firmware Image from a USB | 49 |
| | 5.8.4 | Updating the iSG18GFP's OS | 50 |
| | 5.8.5 | System Database Import/ Export | 51 |
| CHAPTER 6: | | PORT INTERFACES | 54 |
| | 6.1 | Port addressing | 54 |
| | 6.2 | Graphical View of System Interface | 54 |
| | 6.3 | A Logical View of Ports | 55 |
| | 6.4 | Enabling Ports | 55 |
| | 6.5 | ACE Ports | 55 |
| | 6.5.1 | Default State | 56 |
| | 6.5.2 | VLAN Assignment | 56 |
| | 6.6 | Ports FE 0/9-16 | 56 |
| | 6.7 | Serial Ports | 56 |
| | 6.8 | PoE Ports | 56 |
| | 6.8.1 | Power Management of PoE | 57 |
| | 6.8.2 | Mode of PoE | 57 |
| | 6.8.3 | PoE command Hierarchy | 57 |
| | 6.8.4 | PoE Commands Description | 58 |
| | 6.9 | Cellular Ports | 58 |
| | 6.10 | Controlling Ports | 58 |
| | 6.10.1 | Storm Control | 58 |
| | 6.10.2 | Rate Limit Output | 58 |
| | 6.11 | Ports Command Hierarchy | 58 |
| | 6.12 | Ports Commands Description | 60 |
| | 6.12.1 | Port Configuration Example | 62 |
| | 6.12.2 | Configuration Output Example | 64 |
| CHAPTER 7: | | LOGIN AND MANAGEMENT | 66 |
| | 7.1 | Login Authentication Hierarchy | 66 |
| | 7.2 | Login Authentication Commands Description | 67 |
| | 7.3 | Password Commands Hierarchy | 68 |
| | 7.4 | Password Change Procedure (GCE/ACE) | 68 |
| | 7.5 | Password Expiration | 69 |
| | 7.6 | CLI / iDMS User and Password Protection | 69 |
| | 7.7 | Examples | 70 |
| | 7.8 | Privilege Level | 71 |
| | 7.8.1 | Commands Description | 71 |
| | 7.9 | Serial Console Port | 72 |
| | 7.9.1 | Connecting to the Console Port | 72 |
| | 7.9.1.1 | Connecting the device to a PC using the Console Port: ----- | 72 |
| | 7.9.2 | CLI Console Commands | 72 |
| | 7.10 | Management | 73 |
| | 7.10.1 | Default state | 73 |
| | 7.10.2 | Commands Hierarchy | 73 |
| | 7.10.3 | Commands Description | 75 |
| | 7.10.4 | Example | 76 |
| | 7.11 | System Alias | 77 |
| | 7.12 | CLI Pagination | 78 |
| | 7.13 | MAC-Address Table (FDB) | 78 |
| | 7.13.1 | Port Mac Learning Limit | 78 |
| | 7.13.2 | Commands Hierarchy | 79 |

| | | |
|-------------|---|-----------|
| 7.13.3 | Configuration Example, Static MAC entry | 80 |
| 7.13.4 | Example of Exceeding MAC Learning Limit at a port | 80 |
| 7.14 | IP ARP Table..... | 81 |
| 7.14.1 | Commands Hierarchy | 81 |
| 7.14.2 | Configuration Example..... | 82 |

Table of Tables

| | |
|--|----|
| Table 1 – Documentation Suite Details | 9 |
| Table 2 – Acronyms Used in this Document | 11 |
| Table 3 – Power Consumption Details | 15 |
| Table 4 – Command Line Interface | 16 |
| Table 5 – Overview of Supported Features and Corresponding Configuration Environment | 19 |
| Table 6 – Detailed Description of Supported Features and their Configuration Environment | 19 |
| Table 7 – Features and Interfaces Defaults | 21 |
| Table 8 – Root Commands Description..... | 23 |
| Table 9 – GCE Commands Description | 27 |
| Table 10 – Port Addressing Syntax | 54 |
| Table 11 – Ports Default States..... | 56 |
| Table 12 – Ports Default States..... | 56 |
| Table 13 – PoE Commands Description | 58 |
| Table 14 – Ports Commands Description..... | 60 |
| Table 15 – Login Authentication Commands Description | 67 |
| Table 16 – Commands Description | 71 |
| Table 17 – Commands Description | 72 |
| Table 18 – Default State of Features..... | 73 |
| Table 19 – Commands Description | 75 |
| Table 20 – Commands for Creating Alias..... | 77 |
| Table 21 – Commands Hierarchy..... | 81 |

Table of FIGURES

| | |
|---|----|
| Figure 1 - Graphical View of Hardware | 12 |
| Figure 2 – Logical System View | 12 |
| Figure 3 – Distance for Natural Air Flow..... | 13 |
| Figure 4 – Graphical View of System Interface | 54 |

About the Document

1.1 iSG18GFP Overview

The iSG18GFP is an intelligent 18 port compact Service-Aware Ethernet switch, IEC 61850-3 and IEEE 1613 compliant which is designed with a unique strong packet processing application-aware engine to fit the most critical industrial application. The optional support of an integrated firewall on every port of the iSG18GFP provides a network-based distributed security. The switch also contains a VPN gateway with 2 operational modes: inter-site connectivity using IPSec tunnels and remote user access via SSH.



The iSG18GFP is a natural fit for installation at MV/LV transformer sites acting as secure access points for the Distributed Automation control of remote sites. This product is as a secure gateway for Ethernet, IP, and Serial services as an optimized platform for servicing these needs over the network core. The iSG18GFP provides maximum protection against cyber threats.

The iSG18GFP can be managed by the iManage Software Suite (iMSS). The product is made of galvanized steel and has a wide operating temperature from -40°C to +85°C suitable for the harshest of environments without fans.

1.2 Using this Document

1.2.1 Documentation Purpose

This user guide includes the information for installing, configuring and operating the iSG18GFP Ethernet switch. This document contains Section G of the iSG18GFP user manual. The Section G is the General section of the iSG18GFP User Manuals. It provides the complete syntax for the commands available in the currently-supported software version and describes the features supplied with the device.

It includes installation, Configuration Environment (Command Line Interface and navigation, main show commands), System Version and Database, Port Interfaces, Login Management, etc.

For more information regarding the device installation, refer to the “*Installation and Maintenance document.*”

For the latest software updates, see the *Release Notes* for the relevant release. If the release notes contain information that conflicts with the information in the user guide or supplements it, follow the release notes' instructions.

 The Ethernet type of an interface is determined during system startup. While configuring interface-specific parameters, its Ethernet type needs to be specified correctly. A fastethernet interface cannot be configured as a gigabit-ethernet interface and vice-versa.

This part of the document describes the general structure and features of the product.

- For basic networking features, please refer to Section B, iSG18GFP User Manual, Basic, Section B, UM-B-iSG18GFP-4.5.06.01-EN.docx
- For security features, refer to iSG18GFP User Manual, Security, Section S, UM-S-iSG18GFP-4.5.06.01-EN.docx
- For enhanced security features, please refer to iSG18GFP User Manual, Enhanced Security, Section E, UM-E-iSG18GFP-4.5.06.01-EN.docx

1.2.2 Intended Audience

This user guide is intended for network administrators responsible for installing and configuring network equipment. Users must be familiar with the concepts and terminology of Ethernet and local area networking (LAN) to use this User Guide.







1.2.3 Documentation Suite

This document is one part of the full documentation suite provided with this product.

Table 1 – Documentation Suite Details

| You are: | Document Function | Function |
|---|--------------------|---|
| | Installation Guide | Contains information about installing the hardware and software; including site preparation, testing, and safety information. |
|  | User Guide | Contains information on configuring and using the system. |
| | Release Notes | Contains information about the current release, including new features, resolved issues (bug fixes), known issues, and late-breaking information that supersedes information in other documentation |

1.2.4 Conventions Used

| Conventions | Usage | Example |
|---|--|--|
| < > | Parameter inside < > indicate the Input fields of syntax | <integer (100-1000)> |
| [] | Parameter inside [] indicate Optional fields of syntax | [<output file>] |
| { } | Grouping parameters in the syntax | {console} |
| | Separating grouped parameters in the syntax | {console vty <line-number(0-16)>} |
| Calibri (Body) 10 | Example | Your Product# enable 15 |
| Courier New 10 regular blue Courier New 10 regular black | CLI command outputs | Current privilege level is 15 Your Product# show privilege |
|  | Pre-requisites or special information to which the user needs to pay special attention |  Alias name can be set only for the commands having equal to or less than 10 tokens. |
|  | Notes |  BFD support is enabled in an interface by default. |
|  | Caution | Caution. Do not remove the earth connection unless all power supply connections are disconnected |
|  | Danger | Danger. Before connecting power to the platform, make sure that the grounding posts are firmly connected to a reliable ground, as described below. |

1.3 List of Abbreviations

Table 2 – Acronyms Used in this Document

| Acronym | Explanation |
|------------------------|--|
| ACE | Application Configuration Environment |
| ARP | Address Resolution Protocol |
| CLI | Command Line Interface (CLI) |
| Fa or FE | <i>Fa</i> stands for FastEthernet |
| Gi | GigabitEthernet |
| GCE | General Configuration Environment |
| MAC | Media Access Control |
| VLAN | Virtual LAN |
| TCP | Transport Control Protocol |
| OSPF | Open Shortest Path First |
| PoE | Power over Ethernet |
| SCADA | Supervisory Control and Data Acquisition |
| su | <i>substitute user, super user, switch user, or set user</i> |
| USB | Universal Serial Bus |
| WAN | Wide Area Network |

1.4 References

N/A

Hardware and Interfaces

2.1 Graphical View of Hardware



Figure 1 – Graphical View of Hardware

2.2 Logical System View

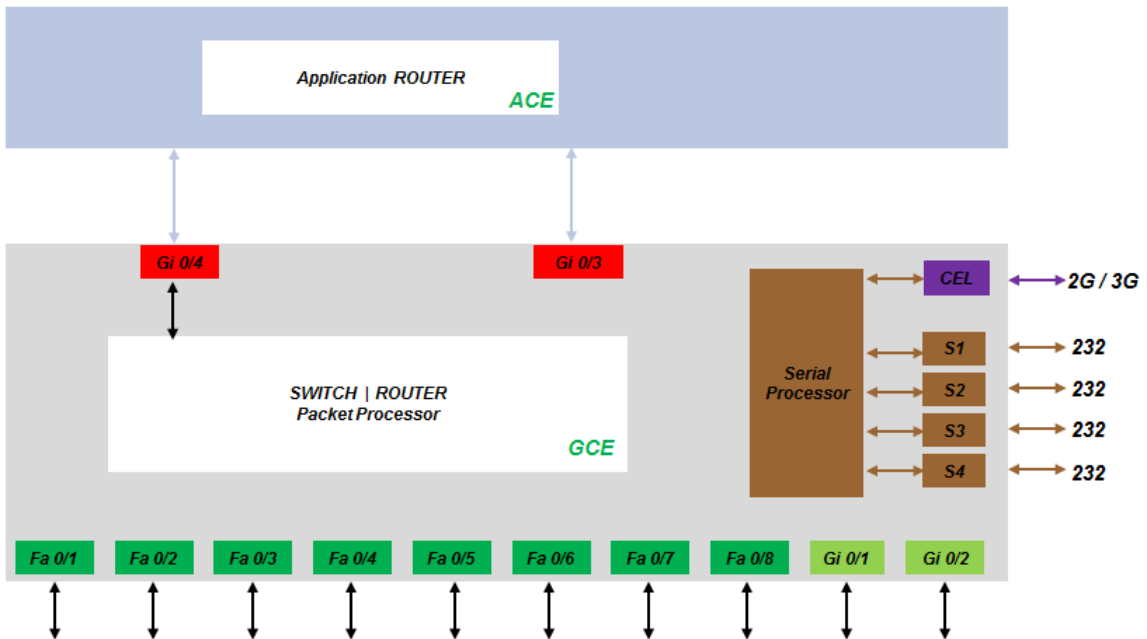

Figure 2 – Logical System View

Installation

3.1 Distance Kept for Natural Air Flow

Proper installation requires keeping 10 cm distance from top and bottom between the iSG18GFP to another neighboring device for proper cooling using natural air flow. Refer to the figure below.



Figure 3 – Distance for Natural Air Flow

3.2 Grounding

1. To install the grounding wire, prepare a minimum 10 American Wire Gauge (AWG) grounding wire terminated by a crimped two-hole lug with hole diameter and spacing as shown in the below figure. Use a suitable crimping tool to fasten the lug securely to the wire. Adhere to your company's policy as to the wire gauge and the number of crimps on the lug.





2. Apply some antioxidant onto the metal surface.
3. Mount the lug on the grounding posts, replace the spring-washers and fasten the bolts. Avoid using excessive torque.



CAUTION

Do not remove the earth connection unless all power supply connections are disconnected.



DANGER

Before connecting power to the platform, make sure that the grounding posts are firmly connected to a reliable ground, as described below.

3.3 Connecting to a Power Source



CAUTION

Please refer to the iSG18GFP installation guide for complete installation instructions.

3.3.1 Wiring DC Input Voltage Feed

Input voltage can be either AC or DC depending on the specific module you purchased. Carefully review the label on the back of the module.

For the DC version, there are 2 connection inputs. They are marked as "PWR A" and "PWR B". For proper operation, it is only necessary to connect one power source, either to "PWR A" or to "PWR B". However, for redundancy purposes you may connect 2 different power sources—one at "PWR A" and the second to "PWR B".

For wiring the voltage, an opposite plug connector (2 pcs) is supplied.

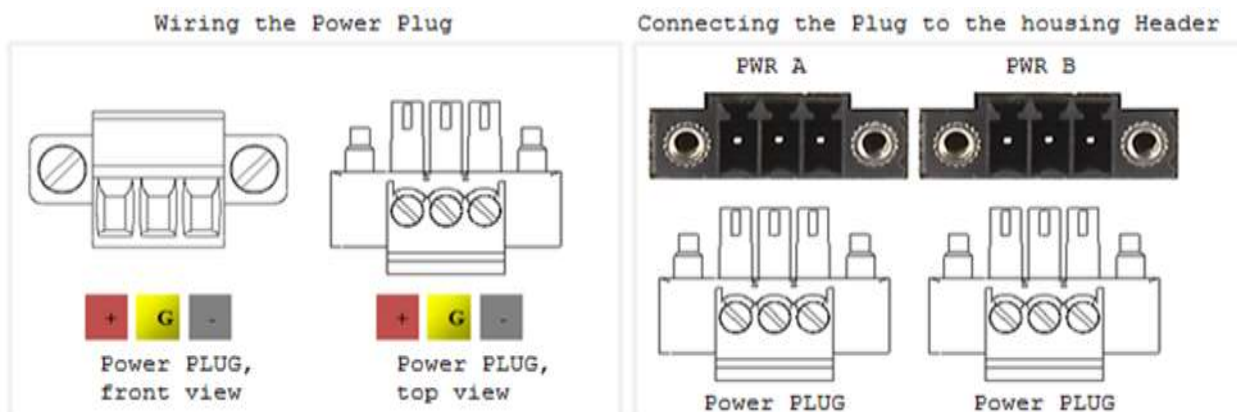

3.3.2 Wiring AC Input Voltage Connector

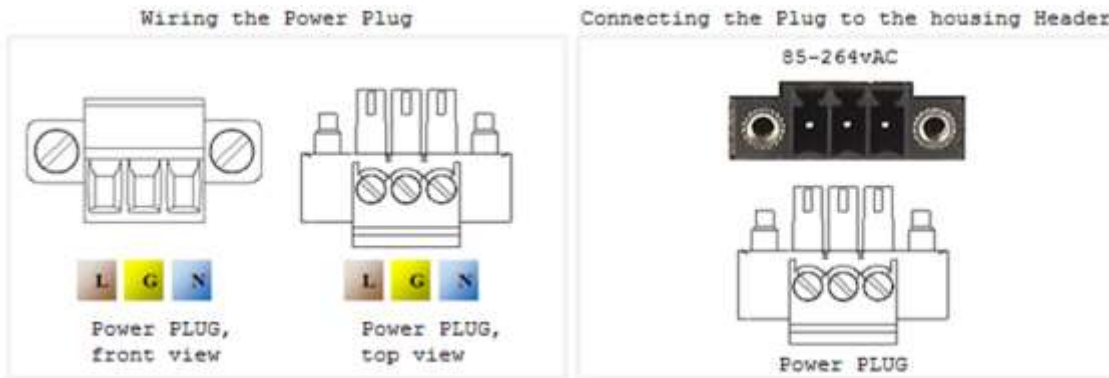

For an AC product option, there is a single input connector

Use a brown wire for the Line (Phase) conductor, a green/yellow for the grounding, and a Blue wire for the neutral conductor. Use 18AWG (1mm2) wire with insulated ferrules.

3.3.3 Power Budget

Please refer to the iSG18GFP installation guide for complete breakdown of power consumption per product group and recommended upstream fuse protection.

Following table details power consumption for any hardware variants (with cellular and serial interfaces).

Table 3 – Power Consumption Details

| Unit Power feed | Max Power [Watt] Version without POE ports | Max Power [Watt] Version with POE ports |
|-----------------|---|---|
| 12 VDC | 20 | 90 |
| 24 VDC | 20 | 130 |
| 48 VDC | 20 | 140 |
| 110 VDC | 20 | 140 |
| 110 VAC | 30 | 140 |
| 220 VAC | 30 | 140 |

Configuration Environment

Two CLI-based configuration environments are available for the user:

1. Global Configuration Environment (GCE)
2. Application Configuration Environment (ACE)

These two environments are complementing each other and allowing each a set of supported interfaces, network tools, and management. At the iSG18GFP infrastructure, the GCE and ACE are representing two different software processing areas. The physical and logical communication between these areas are done by internal switching /routing using the Ethernet gigabit ports Gi 0/3 and Gi 0/4. These are known as the ACE ports.

For additional information about the ACE ports, see the Section 6.5 ACE Ports.

4.1 Command Line Interface

The Command Line Interface (CLI) is used to configure the iSG18GFP from a console attached to the serial port of the switch or from a remote terminal using Telnet or SSH. The following table lists the CLI environments and modes.

Table 4 – Command Line Interface

| Command Mode | Access Method | Prompt | Exit Method |
|-------------------------------------|---|------------------------|---|
| Root | Following user log in this mode is available to the user. | iSG18GFP# | To exit this mode would mean the user to log out from the system. Use the command logout . |
| GCE | Use the command config to enter the Global Configuration mode. | iSG18GFP (config) # | To exit to the Root mode, the commands exit and end are used. |
| Global Hierarchy Configuration | From the Global Configuration mode command, you may drill down to specific feature sub tree. Example is shown here for interface configuration sub tree. | iSG18GFP (config-if) # | To exit to the Global Configuration mode, the exit command is used and to exit to the Root mode, the end command is used. |
| ACE | Use the “ application connect ” from the Privileged mode to enter the application configuration area. | [/] | To exit to the Global Configuration mode, the exit command is used |
| Application Hierarchy Configuration | From the application root, you may drill down to specific feature sub tree. example is shown here for router configuration sub tree using the command “ router ” | [router/]] | To exit to the application root use ‘..’ (two dots). The commands exit and end are not applicable at this sub tree mode. |

4.2 Command Line navigation

4.2.1 Minimum Abbreviation

The CLI accepts a minimum number of characters that uniquely identify a command. Therefore, you can abbreviate commands and parameters as long as they contain enough letters to differentiate them from any other available commands or parameters on the specific CLI mode.

4.2.2 GREP

The 'GREP' and 'GREP -V' allows filtering long show outputs.

'GREP <text>' - filter to output lines which includes the given text.

'GREP -v <text>' - filter to output lines which do not include the given text.

Example:

1. Show running-config vlan without filtering.

```
iSG18GFP# show running-config vlan
#Building configuration...

vlan 4091

ports gigabitethernet 0/1-4

!

!

vlan 1

ports fastethernet 0/1-8 gigabitethernet 0/1-4 untagged fastethernet 0/1-8 gigabitethernet 0/1-2

!

!

vlan 4092

ports gigabitethernet 0/3 fastethernet 0/10-11 untagged fastethernet 0/10-11

!

!

vlan 4093

ports gigabitethernet 0/3

!

!

vlan 10

ports fastethernet 0/1 gigabitethernet 0/3
```

```
!
!
mac-address-table static unicast 02:20:d2:fc:1c:78 vlan 4092 interface gigabitethernet 0/3
mac-address-table static unicast 02:20:d2:fc:1c:79 vlan 4092 interface fastethernet 0/10
mac-address-table static unicast 02:20:d2:fc:1c:7a vlan 4092 interface fastethernet 0/11
```

2. Show running-config vlan with grep filtering.

```
iSG18GFP# show running-config vlan | grep vlan

vlan 4091

vlan 1

vlan 4092

vlan 4093

vlan 10

mac-address-table static unicast 02:20:d2:fc:1c:78 vlan 4092 interface gigabitet...
mac-address-table static unicast 02:20:d2:fc:1c:79 vlan 4092 interface fastether...
mac-address-table static unicast 02:20:d2:fc:1c:7a vlan 4092 interface fastether...
```

4.2.3 Dynamic Completion of Commands

In addition to minimum abbreviation functionality, the CLI can display the commands' possible completions. To display possible command completions, type the partial command followed immediately by <Tab>.

In case that a partial command uniquely identifies a command, the CLI displays the full command. Otherwise, the CLI displays a list of options.

4.2.4 Help (?)

Use "?" to retrieve completion options and as a help for a command.

4.2.5 Keyboard Shortcuts

The following keyboard shortcuts are supported.

1. 'CTRL D'
 - a. At the GCE: moves one CLI mode back.
 - b. At the ACE: exits to GCE Root.
2. 'CTRL Z'
 - a. At the GCE: moves to the ROOT.

4.3 Supported Functionalities

- L2 Ethernet switching
- L3 dynamic and static routing
- SCADA services
- Firewall
- Secure networking

The table below gives an overview of the supported features and their corresponding configuration environment.

Table 5 – Overview of Supported Features and Corresponding Configuration Environment

| Global Configuration Environment (GCE) | | Application Configuration Environment (ACE) | |
|--|----------------|---|-------------------|
| L2 Ethernet switching | Ethernet ports | Serial ports | Cellular modem |
| OSPF | VLAN tagging | IPSec | VPN |
| Management | Authentication | SCADA Gateway | SCADA Firewall |
| L2-L4 Firewall | QOS | Serial services | Terminal services |
| ERP | MSTP | OSPF | RIP |
| FTP | SNMP | NAT | |

The table below details the iSG18GFP supported features and their corresponding configuration environment.

Table 6 – Detailed Description of Supported Features and their Configuration Environment

| Group | Feature | GCE | ACE |
|-----------------------------|--------------------------------------|-----|-----|
| Interfaces | Cellular modem with 2 SIM cards | | X |
| | FE RJ45 Ports | X | |
| | Fiber Optic ports | X | |
| | Gigabit ports | X | |
| | POE ports | X | |
| | RS 232 ports, with control lines | | X |
| | SFP Ports | X | |
| Switching Management | USB | X | |
| | 802.1 | X | |
| | Auto Crossing | X | |
| | Auto Negotiation IEEE 802.3ab | X | |
| | Mac list | X | |
| | Storm Control | X | |
| | VLAN segregation Tagging IEEE 802.1q | X | |
| IGMP Snooping | X | | |
| IGMP v1, v2, v3 | X | | |

| Group | Feature | GCE | ACE |
|------------|--|-----|-----|
| | Backup / Restore running config | X | |
| | Conditioned/ scheduled system reboot | X | |
| | Console serial port | X | |
| | FTP client | X | |
| | Inband Management | X | |
| | Outband Management | X | |
| | Remote Upgrade | X | |
| | Safe Mode | X | |
| | SFTP Client | X | |
| | SNMP Trap | X | |
| | SNMP | X | |
| | SSH Client | X | X |
| | Syslog | X | X |
| | Telnet Client | X | X |
| | Telnet server | X | X |
| | TFTP Client | X | |
| | Web management interface | X | |
| Networking | LLDP | X | |
| | OAM CFM ITU-T Y.1731 | X | |
| | QOS | X | |
| Protection | Conditioned/ scheduled system reboot | | X |
| | ITU-T G.8032v2 Ethernet ring | X | |
| | Link Aggregation with LACP | X | |
| | MSTP IEEE 802.1s | X | |
| | Protection between Cellular ISP (SIM cards backup) | X | |
| | Spanning Tree | X | |
| Routing | DHCP Client | X | |
| | DHCP Relay | X | |
| | DHCP Server | X | |
| | IPv4 | X | X |
| | OSPF v2 | X | X |
| | RIPv2 | | X |
| | Static Routing | X | X |
| | VRRP | X | |
| | NAT | | X |
| Security | ACLs, L2-L4 | X | |
| | Application aware IPS Firewall for SCADA protocols | X | |
| | IEEE 802.1X Port Based Network Access Control. | X | |

| Group | Feature | GCE | ACE |
|----------------|--------------------------------------|-----|-----|
| | IPSec | | X |
| | Local Authentication | X | |
| | MAC limit | X | |
| | Port shutdown | X | |
| | RADIUS Accounting and Authentication | X | |
| | TACACS | X | |
| Time | Local Time settings | X | |
| | NTP | X | |
| Diagnostics | Counters & statistics per Port | X | |
| | Led diagnostics | X | |
| | Ping | X | X |
| | Port mirroring | X | |
| | Relay Alarm Contact | X | |
| | RMON | X | |
| | Trace Route | X | |
| Serial Gateway | IEC 101/104 gateway | | X |
| | IEC 104 Firewall | | X |
| | Serial Transparent Tunneling | | X |
| | Terminal Server | | X |
| VPN | L2 GRE VPN | | X |
| | L3 IPSec VPN | | X |
| | L3 mGRE DM-VPN | | X |

4.4 System Defaults

The following table details the features and interfaces defaults.

Table 7 – Features and Interfaces Defaults

| Feature | Default state |
|-------------------|--|
| Ethernet Ports | All ports are enabled |
| Serial interfaces | Disabled |
| Cellular modem | Disabled |
| VLAN 1 | Enabled (all ports are members) |
| Ports PVID | All Ethernet ports have PVID 1 |
| POE | POE is enabled for supporting hardware |
| Layer 3 interface | Interface VLAN 1 is set to: 10.0.0.1/8 |
| Spanning Tree | MST is enabled. Application ports gigabit 0/3-0/4 are edge ports. Depending on hardware type ports fast 0/9-0/16 may be edge ports as well (ET28 HW variants) |
| ERP | Disabled |

| Feature | Default state |
|----------|---------------|
| LLDP | Disabled |
| SSH | Enabled |
| Telnet | Disabled |
| HTTP | Disabled |
| Syslog | Disabled |
| SNMP | Disabled |
| TACACS | Disabled |
| Radius | Disabled |
| ACLs | Disabled |
| SNTP | Disabled |
| Firewall | Disabled |
| VPN | Disabled |

4.5 Root Commands

The Root Configuration Environment list of main CLI commands is shown below

```
+Root

- Help

- clear screen

- enable

- disable

- configure terminal / configure

- run script

- listuser

- lock

- username

- enable password

- line

- access-list provision mode

- access-list commit

- exec-timeout

- logout

- end

- exit

- show privilege
```

- show line
- show aliases
- show users
- show history

4.6 Root Commands Description

Table 8 – Root Commands Description

| Command | Description |
|-------------------------------|---|
| Help [command] | Displays a brief description for the given command. To display help description for commands with more than one word, do not provide any space between the words |
| clear screen | Clears all the contents from the screen. |
| Enable [<0-15> Enable Level] | Enters into default level privileged mode. If required, the user can specify the privilege level by enabling level with a password (login password) protection to avoid unauthorized user. |
| Disable [<0-15> Enable Level] | Turns off privileged commands. The privilege level varies between 0 and 15. This value should be lesser than the privilege level value given in the enable command. |
| configure [terminal] | Enters configuration mode. |
| run script | Runs CLI commands from the specified script file. |
| listuser | Lists all the default and newly created users, along with their permissible mode. |
| Lock | Locks the CLI console. It allows the user/system administrator to lock the console to prevent unauthorized users from gaining access to the CLI command shell. Enter the login password to release the console lock and access the CLI command shell. |
| username | Creates a user and sets the enable password for that user with the privilege level. |
| alias - replacement string | Replaces the given token by the given string and the no form of the command removes the alias created for the given string. |
| access-list commit | Triggers provisioning of active filter rules to hardware based on configured priority. This command is applicable only when provision mode is consolidated. Traffic flow would be impacted when filter-rules are reprogrammed to hardware. |
| logout | Exits the user from the console session. In case of a telnet session, this command terminates the session. |
| end | Exits the configuration mode |
| exit | Exits the current config location to one step up in the root |
| show privilege | Shows the current user privilege level |
| show line | Displays TTY line information such as EXEC timeout |
| show aliases | Displays all the aliases |
| show users | Displays the information about the current user. |
| show history | Displays a list of recently executed commands |

4.7 GCE Commands

The Global Configuration Environment list of main CLI commands is shown below.

+ Root

+ [Config terminal](#)

default vlan id

default ip address

ip address

default ip address allocation protocol

ip address - dhcp

login authentication

login authentication-default

authorized-manager ip-source

ip http port

set ip http

archive download-sw

interface-configuration and deletion

mtu frame size

system mtu

loopback local

mac-addr

snmp trap link-status

write

copy

clock set

cli console

flowcontrol

shutdown - physical/VLAN/port-channel/tunnel Interface

debug interface

debug-logging

incremental-save

rollback

```
shutdown ospf
start ospf
set switch maximum - threshold
set switch temperature - threshold
set switch power - threshold
mac-learn-rate
system contact
system location
clear interfaces - counters
clear counters
show ip interface
show authorized-managers
show interfaces
show interfaces - counters
show system-specific port-id
show interface mtu
show interface bridge port-type
show nvram
show env
show system information
show flow-control
show debug-logging
show debugging
show clock
show running-config
show http server status
show mac-learn-rate
show config log
management vlan-list <port_list>
show iftype protocol deny table
clear line vty
```

`audit-logging logsize-threshold`

`feature telnet`

`show telnet server`

`show audit`

`set http authentication-scheme`

`set http redirection enable`

`http redirect`

`show http authentication-scheme`

`show http redirection`

4.8 GCE Commands Description

Table 9 – GCE Commands Description

| Command | Description |
|--|--|
| default mode | Configures the mode by which the default interface gets its IP address. |
| default vlan id | Configures the vlan ID for the default interface. |
| default ip address | Configures the IP address and subnet mask for the default interface. |
| ip address | Sets the IP address for an interface. The no form of the command resets the IP address of the interface to its default value. |
| default ip address allocation protocol | Configures the protocol used by the default interface for acquiring its IP address. |
| ip address - dhcp | Configures the current VLAN interface to dynamically acquire an IP address from a DHCP server. |
| login authentication | Configures the authentication method for user logins for accessing the GUI to manage the switch. |
| login authentication-default | Configures the authentication method for user logins for accessing the GUI to manage the switch. |
| authorized-manager ip-source | Configures an IP authorized manager and the no form of the command removes manager from authorized managers list. |
| ip http port | Sets the HTTP port. This port is used to configure the router using the Web interface. The value ranges between 1 and 65535. The no form of the command resets the HTTP port to its default value. |
| set ip http | Enables/disables HTTP in the switch. |
| mtu frame size | Configures the maximum transmission unit frame size for all the frames transmitted and received on all the interfaces in a switch. |
| snmp trap link-status | Enables trap generation on the interface. The no form of this command disables trap generation on the interface. |
| clock set | Manages the system clock. |
| Delete startup-cfg | Clears the contents of the startup configuration |
| cli console | Enables the console CLI through a serial port. The no form of the command disables console CLI. |
| flowcontrol | Set the send or receive flow-control value for an interface |
| [no] shutdown - physical/VLAN/port interface | Disables/enables a physical interface / VLAN interface / port-channel interface |

| Command | Description |
|---|--|
| <code>debug interface</code> | Sets the debug traces for all the interfaces. The no form of the command resets the configured debug traces. |
| <code>debug-logging</code> | Configures the displays of debug logs. Debug logs are directed to the console screen or to a buffer file, which can later be uploaded, based on the input. |
| <code>incremental-save</code> | Enables/disables the incremental save feature |
| <code>auto-save trigger</code> | Enables / disables the auto save trigger function. |
| <code>Rollback { enable disable }</code> | Enables/disables the rollback function. |
| <code>set switch maximum - threshold</code> | Sets the switch maximum threshold values of RAM, CPU, and Flash |
| <code>set switch temperature - threshold</code> | Sets the maximum and minimum temperature threshold values of the switch in Celsius. |
| <code>mac-learn-rate</code> | Configures the maximum number of unicast dynamic MAC (L2) MAC entries hardware can learn on the system |
| <code>system contact</code> | |
| <code>system location</code> | |
| <code>clear interfaces - counters</code> | |
| <code>clear counters</code> | |
| <code>show ip interface</code> | |
| <code>show authorized-managers</code> | |
| <code>show interfaces</code> | |
| <code>show interfaces - counters</code> | |
| <code>show interface mtu</code> | |
| <code>show interface bridge port-type</code> | |
| <code>show nvram</code> | Displays the current information stored in the NVRAM. |
| <code>show env</code> | Displays the status of the all the resources like CPU, Flash and RAM usage, and also displays the current, power and temperature of the switch. |
| <code>show system information</code> | Displays system information. |
| <code>show flow-control</code> | |
| <code>show debug-logging</code> | |
| <code>show debugging</code> | |
| <code>show clock</code> | |

| Command | Description |
|----------------------------------|-------------|
| show running-config | |
| show http server status | |
| show mac-learn-rate | |
| port-isolation in_vlan_ID | |
| show port-isolation | |
| audit-logging reset | |
| show config log | |
| memtrace | |
| show memtrace status | |
| management vlan-list <port_list> | |
| show iftype protocol deny table | |
| clear line vty | |
| login block-for | |
| audit-logging logsize-threshold | |
| feature telnet | |
| show telnet server | |
| show audit | |
| set http authentication-scheme | |
| set http redirection enable | |
| http redirect | |
| show http authentication-scheme | |
| show http redirection | |
| audit-logging reset | |
| show config log | |
| clear line vty | |
| tunnel hop-limit | |
| tunnel hop-limit | |
| login block-for | |
| audit-logging logsize-threshold | |

| Command | Description |
|---|-------------|
| <code>feature telnet</code> | |
| <code>show telnet server</code> | |
| <code>show audit</code> | |
| <code>set http authentication-scheme</code> | |
| <code>set http redirection enable</code> | |
| <code>http redirect</code> | |
| <code>show http authentication-scheme</code> | |
| <code>show http redirection</code> | |
| <code>audit-logging reset</code> | |
| <code>default rm-interface</code> | |
| <code>show config log</code> | |
| <code>show memtrace status</code> | |
| <code>management vlan-list <port_list></code> | |
| <code>show iftype protocol deny table</code> | |
| <code>clear line vty</code> | |
| <code>audit-logging logsize-threshold</code> | |
| <code>feature telnet</code> | |
| <code>show telnet server</code> | |
| <code>show audit</code> | |
| <code>set http authentication-scheme</code> | |
| <code>set http redirection enable</code> | |
| <code>http redirect</code> | |
| <code>show http authentication-scheme</code> | |
| <code>show http redirection</code> | |
| <code>audit-logging reset</code> | |
| <code>show config log</code> | |
| <code>management vlan-list <port_list></code> | |
| <code>internal-lan</code> | |
| <code>show iftype protocol deny table</code> | |

| Command | Description |
|--|-------------|
| <code>clear line vty</code> | |
| <code>login block-for</code> | |
| <code>audit-logging logsize-threshold</code> | |
| <code>feature telnet</code> | |
| <code>show telnet server</code> | |
| <code>show audit</code> | |
| <code>set http authentication-scheme</code> | |
| <code>set http redirection enable</code> | |
| <code>http redirect</code> | |
| <code>show http authentication-scheme</code> | |
| <code>show http redirection</code> | |
| <code>audit-logging reset</code> | |
| <code>show config log</code> | |
| <code>show iftype protocol deny table</code> | |
| <code>clear line vty</code> | |
| <code>login block-for</code> | |

4.9 ACE Commands

The list of main ACE commands is as shown below.

+ Application connect

- + [Router](#) {interface | route |static |ospf |ip |rip| NAT}
- + [cellular](#) {connection | continuous-echo| disable |enable| modem| network| refresh| settings| show| wan}
- + [capture](#) {delete | export |help |show |start |stop}
- + [date](#)
- + [discrete](#) {service| show}
- + [dm-vpn](#) {multipoint-gre| nhrp}
- + [dns](#) {host| resolver}
- + [exit](#)
- + [firewall](#) {log| profile| tcp| serial}
- + [idle-timeout](#)
- + [iec101-gw](#) {cnt| config gw| config iec101| config iec104| operation| show}
- + [ipsec](#) {enable| disable| isakmp update| policy| preshared| log-show| show| show-sa proto}
- + [ipsec-vpn tunnel](#) {show | create | remove}
- + [l2-vpn](#) {fdb| tunnel| nhrp}
- + [ping](#)
- + [reload](#) {cancel| schedule| show}

- + [schedule](#) {add |show |remove}
- + [serial](#) {card |port| local-end-point| remote-end-point}
- + [ssh](#)
- + [ssh-server user](#) {create| remove| show}
- + [syslog show](#)
- + [telnet](#)
- + [terminal-server](#) {admin-status| counters| settings| connections| telnet-service}
- + [trace](#)
- + [version](#)

4.10 Main Show Commands

4.10.1 GCE

[System Information]

os-image show-list

show system information

show env all

[Vlan & Ports]

show vlan

show running-config interface fastethernet 0/<1-8>

show running-config interface gigabitethernet 0/<1-2>

show vlan port config

show interfaces status

[ACLs]

show running-config acl

[FDB]

show mac-address-table

show ip arp

show logging

show interfaces storm-control

[GCE Routing]

show ip interface

show ip route

show ip ospf

show ip ospf neighbor

```
show running-config ospf

show ip rip database

show ip rip statistics

show running-config rip

[SNMP]

show running-config snmp

[STP]

show spanning-tree detail

show spanning-tree summary

[ERP]

show running-config ecfm

show ethernet cfm domain

show ethernet cfm service

show ethernet cfm maintenance-point local

show ethernet cfm maintenance-points remote

show ethernet cfm global information

show aps ring

show aps ring global info
```

4.10.2 ACE

```
[ACE Routing]

router interface show

router route show

router static

enable

show running-config

show ip route

exit

router ospf

enable

show running-config
```

```
show ip ospf route
show ip ospf neighbor
show ip ospf interface
exit
router rip
enable
show running-config
show ip rip
exit
[Cellular]
cellular wan show
cellular settings show
cellular network show
cellular connection show
[VPN & IPSec]
application connect
dm-vpn multipoint-gre
dm-vpn nhrp map
dm-vpn nhrp map
dm-vpn nhrp route-show
l2-vpn tunnel show
l2-vpn fdb show
l2-vpn nhrp spoke show
l2-vpn nhrp hub show
ipsec-vpn tunnel show
ipsec show global-defs
ipsec show preshared
ipsec show sa
ipsec show log
[Serial]
serial card show
```

serial port show

serial local-end-point show

serial port show slot <4-9> port <1-4>

serial remote-end-point show

iec101-gw show all

terminal-server settings show

terminal-server connections show

[Firewall]

show running-config acl

show access-lists

firewall log show

firewall profile show

firewall tcp show

System Version and Database

5.1.1 OS Version

Updating of Operating System (OS) version is possible by TFTP/SFTP server and via USB port. Available OS files on the switch can be seen with the commands showed below. A running OS file is marked with "active".

Upgrading a system OS from a USB drive can be done under Safe Mode interface or a running system assuming that the USB drive was in place when the system was booted.

Notes:

 The OS image file is a *tar* file type. When upgrading the system from the USB the file should be placed at the root directory of the USB drive. The file should not be unzipped.

 The USB drive must be FAT32.

 The iSG18GFP can hold at its disk a maximum of two OS image files. Before downloading a new OS file to the switch, make sure the iSG18GFP has on it only one (the active) file. If needed, delete the unused file before attempting to download a new one.

5.2 Running Configuration

The user can save his running configuration as a file with a chosen name for backup and boot the system with this file when needed.

Multiple running configuration files can be saved with different names locally on the flash or at a TFTP /SFTP server.

It is also possible to import/export a running configuration file to a USB drive from Safe Mode.

5.3 Commands Hierarchy

+ **Root**

- **write startup-cfg**

- **delete startup-cfg**

- **os-image show-list**

- **os-image activate flash:**<file_name>

- **os-image delete flash:** <file_name>

- **os-image download-sw flash:**<file_name>

- **os-image download-sw sftp:**//user:password@aa.bb.cc.dd/file_name

- **os-image download-sw tftp:**//aa.bb.cc.dd/file_name

- **startup-config** {**import** | **export**}
 - [**flash**: <file_name> |
 - sftp**://user:password@aa.bb.cc.dd/<file_name> |
 - tftp**://aa.bb.cc.dd/<file_name>]

 - **logs-export** [**flash**: <file_name> |
 - sftp**://user:password@aa.bb.cc.dd/<file_name> |
 - tftp**://aa.bb.cc.dd/<file_name>]
-
- **startup-config show files**
 - **reload**

 System must be rebooted following activation of a new OS image file.

5.4 Upgrading the OS

The OS can be upgraded from a USB or SFTP.

5.4.1 From USB

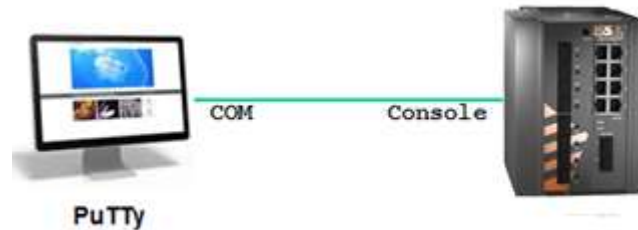

Figure 4 – Upgrading OS from USB

To upgrade the OS image file from a USB, perform the following:

1. Connect to the switch via console and establish CLI management.
2. Prepare a USB stick, formatted to FAT32 and with the OS version at its root directory.
3. Display available OS files

```
iSG18GFP# os-image show-list
```

```
Versions list:
```

```
RF_3180_3.5.03.11 (active)
```

```
RF_3180_3.1.00.25.tar
```

4. Delete unneeded OS files

```
iSG18GFP# os-image delete flash:RF_3.1.00.25.tar
```

```
iSG18GFP# os-image show-list
```

```
Versions list:
```

```
RF_3180_3.5.03.11 (active)
```

```
iSG18GFP#
```

5. Download an OS file from USB.

Command syntax:

```
iSG18GFP # os-image download-sw flash:<file_name>
```

Example:

```
iSG18GFP# os-image download-sw flash:RF_3180_3.5.04.15.tar
```

```
iSG18GFP# os-image show-list
```

Versions list:

```
RF_3180_3.5.03.11 (active)
```

```
RF_3180_3.5.04.15.tar
```

```
iSG18GFP#
```

6. Activate desired OS file (this will automatically reboot the device)

```
iSG18GFP# os-image activate flash:RF_3180_3.5.04.15.tar
```

```
iSG18GFP# os-image show-list
```

Versions list:

```
RF_3180_3.5.03.11
```

```
RF_3180_3.5.04.15.tar (active)
```

5.4.2 From SFTP

To upgrade the OS image file from a SFTP server, perform the following:

1. Display the available OS files.

```
iSG18GFP# os-image show-list
```

Versions list:

```
RF_3180_3.5.03.11 (active)
```

```
RF_3180_3.1.00.25.tar
```

2. Delete unneeded OS files.

```
iSG18GFP# os-image delete flash:RF_3.1.00.25.tar
```

```
iSG18GFP# os-image show-list
```

Versions list:

```
RF_3180_3.5.03.11 (active)
```

```
iSG18GFP#
```

3. Download OS file from SFTP.

Command syntax:

```
iSG18GFP# os-image download-sw sftp://user:password@aa.bb.cc.dd/file_name
```

Example:

```
iSG18GFP# os-image download-sw sftp://user:user@172.17.203.100/RF_3180_3.5.04.15.tar
```

```
----25%-----50%-----75%-----100%
```

```
iSG18GFP# os-image show-list
```

Versions list:

```
RF_3180_3.5.03.11 (active)
```

```
RF_3180_3.5.04.15.tar
```

```
iSG18GFP#
```

4. Activate desired OS file (will automatically reboot the device)

```
iSG18GFP# os-image activate flash:RF_3180_3.5.04.15.tar
```

Switch booting...

```
iSG18GFP# os-image show-list
```

Versions list:

```
RF_3180_3.5.03.11
```

```
RF_3180_3.5.04.15.tar (active)
```

5. Export configuration database to SFTP server

Command syntax:

```
iSG18GFP# startup-config export sftp://user:password@aa.bb.cc.dd/file_name.
```

Example:

```
iSG18GFP# startup-config export sftp://rad:rad@172.18.212.230/config_january13
```

5.5 Example of Exporting DB and Logs

The following flow will show how to export configuration and logs to a TFTP server.

1. Exporting configuration database (DB) to SFTP server

Command syntax:

```
iSG18GFP# startup-config export sftp://user:password@aa.bb.cc.dd/file_name.
```

Example:

```
iSG18GFP# startup-config export sftp://rad:rad@172.18.212.230/config_january13
```

2. Exporting logs base to SFTP server

Command syntax:

```
iSG18GFP# logs-export sftp://<user-name>:<pass-word>@ip-address/filename
```

Example:

```
iSG18GFP# logs-export sftp://rad:rad@172.18.212.230/logs_january13
```

5.6 Example of Exporting DB Files to Flash Drive

The following flow will show how to export configuration as a file to the local flash drive.

1. Exporting configuration data

```
iSG18GFP# startup-config export flash:db_march
```

```
iSG18GFP# startup-config show files
```

```
db_february
```

```
db_test
```

```
db_march
```

2. Activating DB file from flash

```
iSG18GFP# startup-config import flash: db_february
```

```
startup-config import Successful
```

```
Reload to use new db
```

```
iSG18GFP# reload
```

5.7 Example of Importing DB from TFTP

The following flow will show how to import configuration from a TFTP server.

1. Establish connectivity between the switch and the TFTP server
2. Start importing the target file

```
iSG18GFP# startup-config import tftp://172.18.212.231/RF1_ospf.cfg
```

downloaded size:2408448 Bytes

startup-config import Successful

Reload to use new db

1. Reload the switch for the data base to take effect

iSG18GFP# reload

..

..

RF1 login: su

Password:

<129>Mar 10 09:06:28 RF1 CLI Attempt to login as su via console Succeeded

RF1#

5.8 Safe Mode

The system has two Safe Mode menus available. To access Safe Mode, connect to the switch via console cable, reboot the unit, and interrupt the boot process at the Safe Mode prompt.

The first Safe mode is used for approved technician only and should not be used unless specified iS5Com. This Safe Mode state is available at the prompt "For first safe mode Press 's'..."

The second safe mode is accessible at the following prompt:

#####

For safe mode Press 's'...

#####

The following screenshot details the 2 Safe Mode menus and their options:

1. system reset
2. Load the factory-default configuration for the device
3. Write to EEPROM (should be used only after consulting with iS5Com)
4. Recover the device's images from a package file
5. Export / Import DB (running configuration)

For first safe mode Press 's'...

s

Safe mode requested from boot...

```
|safe mode menu:          |
|  reset      | 1 : Reset the device    |
|  format     | 2 : Format flash        |
|  activate   | 3 : Activate sw version |
|  install    | 4 : Install first sw    |
|  other      | o : write other type    |
|  continue   | c : Continue with start |
|  help       | H : Display help about  |
|             |                          |
-----c
```

Extracting software

|s

OK

01/01/70 00:25:34 Running applications

#####

For safe mode Press 's'...

#####

```
|safe mode menu:
|  reset      | 1 : Reset the device
|  defcfg     | 2 : Load the factory-default configuration for the device
|  eeprom     | 3 : Write to EEPROM
|  recover    | 4 : Recover the device's images from a package file
|  db         | 5 : Export / Import DB
|  continue   | c : Continue in start up process
|  refresh    | r : Refresh menu
|  help       | H : Display help about this utility
|             |
-----|
```

5.8.1 **SW-OS** Image Upgrade and Recovery

From the second Safe Mode, select option 4 - "Recover the device's images from a package file".

At this sub menu, the user can handle system version update, activation, or restore.

```
-----
|safe mode menu:
|  reset      | 1 : Reset the device
|  defcfg     | 2 : Load the factory-default configuration for the device
|  eeprom     | 3 : Write to EEPROM
|  recover    | 4 : Recover the device's images from a package file
|  db         | 5 : Export / Import DB
|  continue   | c : Continue in start up process
|  refresh    | r : Refresh menu
|  help       | H : Display help about this utility
-----

4

#####
### Device Image Recovery #####
#####

usb      | 1 : Download the package file from USB
ls       | 2 : List the available application files
active   | 3 : Change the active working application
show     | 4 : Display the active working application
remove   | 5 : Delete an application
free     | 6 : Display the free space in the application file system
main     | X : Return to the main menu
help     | H : Display help about this menu
```

5.8.2 Uploading OS Image Update from USB

Follow the steps below for an example of uploading an OS image stored on a local USB key and activating it.

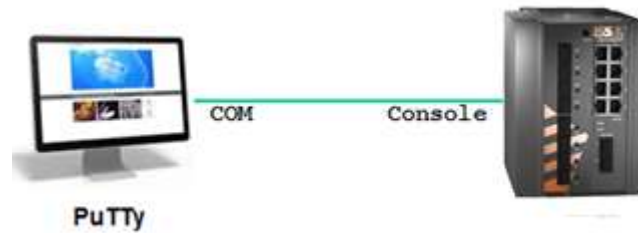

Figure 5 – Uploading OS Image from USB

- To access the second Safe Mode, use Option 4 and 5 and list the current OS images available at the switch.

```

-----
|safe mode menu:

| reset      | 1 : Reset the device
| defcfg    | 2 : Load the factory-default configuration for the device
| eeprom    | 3 : Write to EEPROM
| recover    | 4 : Recover the device's images from a package file
| db        | 5 : Export / Import DB
| continue  | c : Continue in start up process
| refresh    | r : Refresh menu
| help      | H : Display help about this utility
-----

4

#####

### Device Image Recovery #####

#####

usb      | 1 : Download the package file from USB
ls       | 2 : List the available application files
active   | 3 : Change the active working application
show     | 4 : Display the active working application
remove   | 5 : Delete an application
free     | 6 : Display the free space in the application file system

```

main | X : Return to the main menu
help | H : Display help about this menu

2

List of sw versions:

3.5.04.32 (active)

3.5.04.15

2. Delete the unused OS Image file by choosing Option 4 and then Option 5.

|safe mode menu:
| reset | 1 : Reset the device
| defcfg | 2 : Load the factory-default configuration for the device
| eeprom | 3 : Write to EEPROM
| recover | 4 : Recover the device's images from a package file
| db | 5 : Export / Import DB
| continue | c : Continue in start up process
| refresh | r : Refresh menu
| help | H : Display help about this utility

4

Device Image Recovery #####
#####

usb | 1 : Download the package file from USB
ls | 2 : List the available application files
active | 3 : Change the active working application
show | 4 : Display the active working application
remove | 5 : Delete an application
free | 6 : Display the free space in the application file system
main | X : Return to the main menu
help | H : Display help about this menu

5

List of sw versions:

3.5.04.32 (active)

3.5.04.15

Enter version name

For main menu press X

3.5.04.15

Removing version 3.5.04.15

Version was deleted successfully

3. Download a new OS Image file from the USB. A list of available files at the USB will be displayed. Copy the complete file name and path. Below examples shown relate to version 4.0.02.10.tar. Choose Options 4 and 1.

|safe mode menu:

| | |
|----------|---|
| reset | 1 : Reset the device |
| defcfg | 2 : Load the factory-default configuration for the device |
| eeprom | 3 : Write to EEPROM |
| recover | 4 : Recover the device's images from a package file |
| db | 5 : Export / Import DB |
| continue | c : Continue in start up process |
| refresh | r : Refresh menu |
| help | H : Display help about this utility |

4

#####

Device Image Recovery

#####

| | |
|--------|--|
| usb | 1 : Download the package file from USB |
| ls | 2 : List the available application files |
| active | 3 : Change the active working application |
| show | 4 : Display the active working application |

```

remove    | 5 : Delete an application

free      | 6 : Display the free space in the application file system

main      | X : Return to the main menu

help      | H : Display help about this menu

```

1

```

-rw-rw-rw- 1 root  root  58112000 Jan 21  2014 /mnt/usb/RF_3180_3.5.04.15.tar
-rw-rw-rw- 1 root  root  59494400 Apr  7  2014 /mnt/usb/RF_3180_3.5.04.31.tar
-rw-rw-rw- 1 root  root  59555840 Jun  5  2014 /mnt/usb/RF_3180_3.6.04.24.tar
-rw-rw-rw- 1 root  root  59842560 Jun  2  2014 /mnt/usb/RF_3180_4.0.02.10.tar

```

Enter version number on USB.

For main menu press X

/mnt/usb/RF_3180_4.0.02.10.tar

Version was installed successfully

4. Activate the new version. Select Options 4 and 3. The system will boot.

```

-----
|safe mode menu:

|  reset      | 1 : Reset the device

|  defcfg     | 2 : Load the factory-default configuration for the device

|  eeprom     | 3 : Write to EEPROM

|  recover    | 4 : Recover the device's images from a package file

|  db         | 5 : Export / Import DB

|  continue   | c : Continue in start up process

|  refresh    | r : Refresh menu

|  help       | H : Display help about this utility

-----

```

4

```

#####
### Device Image Recovery #####
#####

```

```

usb      | 1 : Download the package file from USB
ls       | 2 : List the available application files
active   | 3 : Change the active working application
show     | 4 : Display the active working application
remove   | 5 : Delete an application
free     | 6 : Display the free space in the application file system
main     | X : Return to the main menu
help     | H : Display help about this menu

```

```
3
```

```
List of sw versions:
```

```
3.5.04.32 (active)
```

```
4.0.02.10
```

```
Enter version to activate
```

```
For main menu press X
```

```
4.0.02.10
```

```
Updating bank1 with vmlinux.UBoot file, please wait ...
```

5.8.3 Installing First Firmware Image from a USB

Follow the steps below for an example of installing a first version from a USB. Local database and any active OS image will be deleted. The system will be booted with manufacturing defaults using the new firmware file.

1. To access the first type of Safe Mode, use Option 4 “install”. Select the version to be used. The system will be booted automatically to activate the new OS.

```

-----
Safe mode requested from boot...
-----
|safe mode menu:                |
| reset      | 1 : Reset the device         |
| format     | 2 : Format flash              |
| activate   | 3 : Activate sw version on flash |
| install    | 4 : Install first sw version from USB |
| other      | o : write other type field     |

```

```
| continue | c : Continue with start up process |
| help     | H : Display help about this utility |
```

4

```
!!!!!!!!!!!!!!!!!!!!!!!!!!!!!!!!!!!!!!!!!!!!!!!!!!!!!!!!!!!!!!!!!!!!
!!!!!!!!!!!!!!!!!!!! This choice will delete data from flash !!!!!!!!!!!!!!!
!!!!!!!!!!!!!!!!!!!!          Continue [y/n]          !!!!!!!!!!!!!!!!!!!!!
!!!!!!!!!!!!!!!!!!!!!!!!!!!!!!!!!!!!!!!!!!!!!!!!!!!!!!!!!!!!!!!!!!!!
```

y

```
-rw-rw-rw-  1 root  root  58112000 Jan 21  2014 /mnt/usb/RF_3180_3.5.04.15.tar
-rw-rw-rw-  1 root  root  59842560 Jun  2  2014 /mnt/usb/RF_3180_4.0.02.10.tar
```

Enter version number on usb.
For main menu press X

```
/mnt/usb/RF_3180_3.5.04.15.tar
```

Verifying sw version RF_3180_3.5.04.15.tar

bcm_sdk_iss_app.tar.gz: OK

SW version was verified successfully

vmlinux.tar

vmlinux.UBoot: OK

Updating bank1 with vmlinux.UBoot file, please wait ...OK

5.8.4 Updating the iSG18GFP’s OS

Certain firmware updates may require an update to the iSG18GFP’s OS. Such updates will include the OS image (also referred to as Uboot file) provided to you by the iS5Com support team. Upon obtaining the OS file, follow these steps:

1. Log in the iSG18GFP using the console command line interface.
2. Connect a USB memory device with the OS version file in the root folder of it and the vmlinux.Uboot located in a “ramdisk” folder.
-  iSG18GFP looks for the Uboot in a directory named “ramdisk”. Make sure that the right Uboot is placed there.
3. ~~Reload~~ **Reboot** the iSG18GFP. CLI command is reloaded.
4. Stop the boot process in Uboot point. To do so, when you see the countdown 3,2,1, press Enter.
5. Run the following command from Uboot state: “run update_bank1”.
6. Run the following command from Uboot state: “run safemode”.
7. Press 4 (this is the option to install the version via USB)
8. Write the full path of **SW-OS** version.

5.8.5 System Database Import/ Export

To import/ export system configuration database, access the second Safe Mode.

1. To access second Safe Mode, use Option 4 “recover” and list the current OS images available at the switch.

```
-----
|safe mode menu:
|  reset      | 1 : Reset the device
|  defcfg     | 2 : Load the factory-default configuration for the device
|  eeprom     | 3 : Write to EEPROM
|  recover    | 4 : Recover the device's images from a package file
|  db         | 5 : Export / Import DB
|  continue   | c : Continue in start up process
|  refresh    | r : Refresh menu
|  help       | H : Display help about this utility
-----
4
-----
|safe mode menu:
|  reset      | 1 : Reset the device
|  defcfg     | 2 : Load the factory-default configuration for the device
|  eeprom     | 3 : Write to EEPROM
|  recover    | 4 : Recover the device's images from a package file
|  db         | 5 : Export / Import DB
|  continue   | c : Continue in start up process
|  refresh    | r : Refresh menu
|  help       | H : Display help about this utility
-----
```

2. At the sub menu, select Option 5 “db”. Use Option 3 to view available db files at the USB (for import). The shown below example demonstrates importing a db file named “ss_spoke1” from the USB and booting the system with it.

```
3
List of db files on usb:
```

```
-rwxr-xr-x 1 root root 2503168 Jan 1 1980 ss_spoke1
```

|safe mode menu:

- | reset | 1 : Reset the device
- | defcfg | 2 : Load the factory-default configuration for the device
- | eeprom | 3 : Write to EEPROM
- | recover | 4 : Recover the device's images from a package file
- | db | 5 : Export / Import DB
- | continue | c : Continue in start up process
- | help | H : Display help about this utility

5

#####

Export / Import DB

#####

- export | 1 : Export DB to usb
- import | 2 : Import DB from usb
- list | 3 : Show list of db files on usb
- main | X : Return to the main menu
- help | H : Display help about this menu

2

Import Db from usb

Enter file name

ss_spoke1

|safe mode menu:

- | reset | 1 : Reset the device
- | defcfg | 2 : Load the factory-default configuration for the device
- | eeprom | 3 : Write to EEPROM
- | recover | 4 : Recover the device's images from a package file
- | db | 5 : Export / Import DB

| continue | c : Continue in start up process

| help | H : Display help about this utility

C

.....

Port Interfaces

6.1 Port addressing

Ports are configured as <interface-type> <port id>.

Table 10 – Port Addressing Syntax

| Command | Description |
|-------------------|--|
| interface-type <> | Specifies the interface type Fastethernet (F) gigabitethernet (G) |
| Port id <> | Specifies the port id in a slot number/port format Slot number is: 0 for Ethernet ports, 1 for Serial ports) Port number is in the range of 0-16 (depending on hardware configuration) |

6.2 Graphical View of System Interface

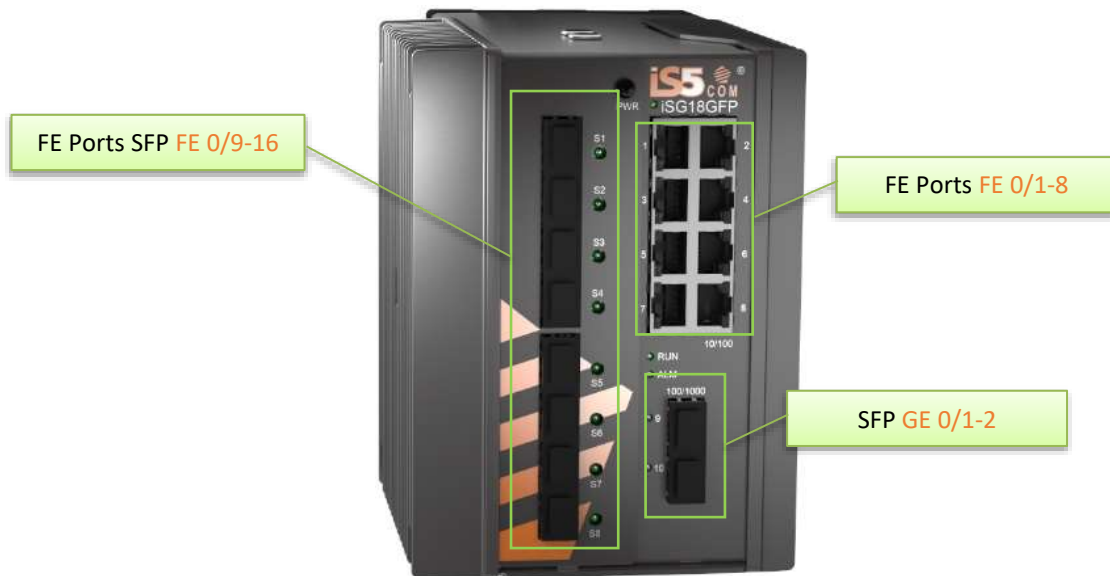

Figure 6 – Graphical View of System Interface

6.3 A Logical View of Ports

The screenshots below show available typical ports of a ISG18GFP with 8 Ethernet ports.

```



3180# show vlan

Switch default

Vlan database
-----
Vlan ID          : 1
Member Ports     : Fa0/1, Fa0/2, Fa0/3, Fa0/4, Fa0/5, Fa0/6
                  Fa0/7, Fa0/8, Gi0/1, Gi0/2, Gi0/3, Gi0/4
Untagged Ports   : Fa0/1, Fa0/2, Fa0/3, Fa0/4, Fa0/5, Fa0/6
                  Fa0/7, Fa0/8, Gi0/1, Gi0/2
Forbidden Ports  : None
Name             :
Status           : Permanent
-----
Vlan ID          : 4092
Member Ports     : Gi0/3, Fa0/10, Fa0/11
Untagged Ports   : Fa0/10, Fa0/11
Forbidden Ports  : None
Name             :
Status           : Permanent
-----

```

Fa stands for FastEthernet and *Gi* for GigabitEthernet.

-  The RS232 ports are configured and identified within the ACE CLI mode and are not seen at “show vlan”.
-  The iSG18GFP has several hardware ordering options of interfaces. The Ethernet interfaces which are applicable to the hardware will be available for configuration.

6.4 Enabling Ports

To be accessible, the required interfaces must be activated. This is done using the no shutdown command.

1. An example of enabling port interface number 5 is as follows.

```

iSG18GFP(config)# interface fastethernet 0/5

iSG18GFP(config-if)# no shutdown

iSG18GFP(config-if)# end

iSG18GFP# write startup-cfg

```

-  System Default is when all ports are enabled.

The *show interfaces* command displays the complete information of all available interfaces.

6.5 ACE Ports

Ports Gigabitethernet 0/3 and Gi 0/4 are unique ports. These are internal system ports used for directing access and network traffic handled at the GCE to the Application services. [Is that the same for us?](#)

The use of these ports should be made in accordance to the configuration instructions as shown in the following chapters of this manual.

6.5.1 Default State

Table 11 – Ports Default States

| Vlan id / port | Gi 0/3 | Gi 0/4 |
|----------------|---------------|--------|
| Vlan 4092 | Tagged | |
| Vlan 4093 | Tagged | |
| Vlan 1 | Tagged (pvid) | Tagged |

 The ACE ports properties should not be changed from their default auto-negotiation and hybrid state settings.

6.5.2 VLAN Assignment

The assignment of an ACE port to a VLAN is always as a tagged member.

The following table summarizes the ports VLAN membership depending on the network planning.

Table 12 – Ports Default States

| Networking / port | Gi 0/3 | Gi 0/4 |
|-------------------|---------------|---------------|
| Serial tunneling | Service VLANs | |
| Terminal Server | Service VLANs | |
| Gateway | Service VLANs | |
| L2 VPN | NNI Vlan | UNI VLAN |
| L3 VPN | NNI Vlan | |
| IPsec | NNI Vlan | |
| Cellular | | |
| Firewall | | Service VLANs |

6.6 Ports FE 0/9-16

The usage of ports FE 0/9 -16 (FE Ports SFP) is dependent on the hardware option as follows:

- iSG18GFP-MV-HV-D-8RJ45-2GSFP-4SFP-4SFP-SE
- iSG18GFP-MV-HV-D-8RJ45-2GSFP-4SFP-XX-SE
- iSG18GFP-MV-HV-D-8RJ45-2GSFP-XX-XX-SE

 With hardware versions of ET28 these ports properties should not be changed from their default settings of auto-negotiation and hybrid state.

6.7 Serial Ports

There are hardware options with 4 x RS-232 RJ45 Serial Ports (4SRJ45.) with 2kV Isolation- iSG18GFP- 2GSFP-4SRJ45 or iSG18GFP- XX- 4SRJ45.

6.8 PoE Ports

Depending on your hardware variant PoE ports may be available. PoE is supported at the RJ45 ports only.

The hardware options supporting POE are as follows:

- iSG18GFP-HV (PoE)-D-8PRJ45-2GSFP-4SFP-4SFP—hardware includes 8 PoE support on the FE Ethernet ports 1-8. All PoE ports are wired as Alternative-A (PoE runs on the FE twisted pairs). Each port supports up to 30 Watt max PoE. The input for PoE 90-250VAC Note the total PoE power allowed per the unit and per port group.
- iSG18GFP-HV (PoE)-D-8PRJ45-2GSFP-4RJ45-XX
- iSG18GFP-HV (PoE)-D-8PRJ45-2GSFP-4SRJ45-XX

6.8.1 Power Management of PoE

1. The eight PoE ports support in total maximum power output of:
 - a. For 12 VDC powered units (RF-3180-24../PE): 70 Watt
 - b. For 24 VDC powered units (RF-3180-24../PE): 90 Watt
 - c. For 48 VDC powered units (RF-3180-48../PE): 120 Watt or 240 Watt
 - d. For 110 VDC powered units (RF-3180-11../PE): 90 Watt
 - e. For AC powered units (RF-3180-AC../PE): 120 Watt for 110 VAC or 240 Watt for 220 VAC.
2. For redundancy purposes, the ports are divided into two groups:
 - a. Group 1: p1, p2, p3, p6
 - b. Group 2: p4, p5, p7, p8

6.8.2 Mode of PoE

“Alternative-A” wired ports supply PoE power on demand. Non-PoE equipment connected to such port is protected as it will not receive power over the Fast Ethernet communication lines.

6.8.3 PoE command Hierarchy

+ Root

+ config terminal

+ interface <type> <port id>



- poe-power { detect | manual }

- poe { shutdown | no shutdown }

- show poe-status port <1-8>

6.8.4 PoE Commands Description

Table 13 – PoE Commands Description

| Command | Description |
|----------------------------|--|
| Config terminal | Go to Global Configuration mode. |
| Interface <type> <port id> | Enter the specific Interface. Only fastethernet ports are applicable. Permissible values: Fastethernet <1-8> |
| Poe | No shutdown: port is POE enabled. Shutdown: port is POE disabled. (default) |
| poe-power | Detect: POE will be available only upon negotiation with a POE connected load device. (default) Manual: POE will be available constantly.  Caution: connect only POE capable load devices to ports which are in Manual mode.  Note : ports which are hardware Alternate-B must be in Manual mode. |
| show poe-status port <> | Show the POE state of the port. Port number is in the range 1-8, when related to fastethernet 1-8. |

6.9 Cellular Ports

| Cellular Port | Description |
|---------------|---|
| 2SIM-LTE1 | Dual SIM LTE Modem with 3G fallback, International |
| 2SIM-LTE2 | Dual SIM LTE Modem with 3G fallback, Americas (AT&T, Generic) |
| 2SIM-LTE3 | Dual SIM LTE Modem with 3G fallback, Americas (Verizon) |
| 2SIM-LTE4 | Dual SIM LTE Modem with 3G fallback, Americas (Sprint) |
| 2SIM-LTE5 | Dual SIM LTE Modem with 3G fallback, Americas (Bell, Rogers, Telus) |

6.10 Controlling Ports

6.10.1 Storm Control

Sets the storm control rate for broadcast, multicast, and DLF packets.

6.10.2 Rate Limit Output

Enables the rate limiting and burst size rate limiting by configuring the egress packet rate of an interface. The no form of the command disables the rate limiting and burst size rate limiting on an egress port.

6.11 Ports Command Hierarchy

+ Root

+ config terminal

+ interface [range] <type> {<port id>| <iface_list>}

- [no] **alias** DESCRIPTION
- [no] **speed** (10 | 100 | 1000 | auto)
- [no] **duplex** (auto | full | half)
- [no] **switchport pvid** <vlan ID>
- [no] **switchport mode** {access | trunk | hybrid}
- [no] **switchport acceptable-frame-type** {all | tagged | untaggedAndPrioritytagged}
- [no] **system-specific port-id** <id>
- [no] **snmp trap link-status**
- [no] **negotiation**
- **flowcontrol** (receive | send) (desired | on | off)
- **mtu** <mtu-value>
- [no] **shutdown**
- [no] **storm-control** { broadcast | multicast | dlf } level <pps (1-250,000)>
- [no] **rate-limit output** [rate-limit] [burst-limit]
- **switchport unicast-mac learning limit** <limit value(0-32767)>
- **switchport unicast-mac learning** { enable | disable }

clear interfaces [<interface-type> <interface-id>] **counters**

clear counters [<interface-type> <interface-id>]

- **Show interfaces** [<interface-type> <interface-id>] [vlan <vlan-id>]

- **Show interfaces** <type> <port id>

- **show interface mtu**

- **show interfaces status**

- **show interfaces counters**

- **show interfaces capabilities**

- **show vlan port config** [port <type> <port id>]

- **show running-config interface** <type> <port id>

6.12 Ports Commands Description

Table 14 – Ports Commands Description

| Command | Description |
|----------------------------------|--|
| Config terminal | |
| Interface <type> <port id> | |
| Alias | Set a description name for the port. |
| Speed | Set manual speed to the port. Requires first disabling 'negotiation' at the port. Default: negotiation enabled. |
| Duplex | Set port duplex as full half auto. Default: full |
| switchport mode | Configures the mode of operation for a switch port. This mode defines the way of handling of traffic for VLANs. Access: accepts and sends only untagged. This kind of port is added as a member to specific VLAN only and carries traffic only for the VLAN to which the port is assigned. This mode is allowed only if the port is not a tagged member at any VLAN. The port property of "switchport acceptable-frame-type" must be set to untagged AND priority Tagged". Trunk: accepts and sends only tagged frames. This kind of port is added as member of all existing VLANs and for any new VLAN created, and it carries traffic for all VLANs. The trunk port accepts untagged frames too, if the "switchport acceptable-frame-type" is set as "all". The port can be set as trunk port, only if the port is not a member of untagged ports for any VLAN in the switch. Hybrid: Configures the port as hybrid port that accepts and sends both tagged and untagged frames. Default: Hybrid |
| switchport pvid | The PVID represents the VLAN ID that is to be assigned to untagged frames. The packets are processed against PVID, if the packets accepted at ingress is not having a tag. Permissible range: 1-4000. default: 1. |
| switchport acceptable-frame-type | |
| negotiation | Enables port auto negotiation of speed. default: enabled |

| Command | Description |
|---|---|
| <pre>mtu frame size</pre> | <p>This command configures the maximum transmission unit frame size for all the frames transmitted and received on all the interfaces in a switch. The size of the MTU frame size can be increased using this command. The value ranges between 90 and 9216.</p> <p>This value defines the largest PDU that can be passed by the interface without any need for fragmentation. This value is shown to the higher interface sub-layer and should not include size of the encapsulation or header added by the interface. This value represents the IP MTU over the interface, if IP is operating over the interface.</p> <p>Note: Any messages larger than the MTU are divided into smaller packets before transmission</p> <p>Default: 1500</p> |
| <pre>system-specific port-id <></pre> | <p>This command configures the system specific index for the port. It provides a different numbering space other than the IfIndex to identify ports. The value ranges between 1 and 16384.</p> <p>Default: 0.</p> |
| <pre>[no] snmp trap link-status</pre> | <p>This command enables trap generation on the interface. The no form of this command disables trap generation on the interface.</p> <p>The interface generated linkUp or linkDown trap. The linkUp trap denotes that the communication link is available and ready for traffic flow. The linkDown trap denotes that the communication link failed and is not ready for traffic flow.</p> <p>Default: enable</p> |
| <pre>flowcontrol</pre> | |
| <pre>{ send receive}</pre> | <p>Send: Sets the interface to send flow control packets to a remote device</p> <p>Receive: Sets the interface to receive flow control packets from a remote device</p> |

| Command | Description |
|--|---|
| <code>{ on off desired}</code> | <p>On: If used with receive allows an interface to operate with the attached device to send flow control packets. If used with send the interface, it sends flowcontrol packets to a remote device if the device supports it.</p> <p>Off: Turns-off the attached devices (when used with receive) or the local ports (when used with send) ability to send flow-control packets to an interface or to a remote device respectively</p> <p>Desired: Allows a local port to operate with an attached device that is required to send flow control packets or that may send the control packets, when used with receive option.</p> <p>Allows the local port to send administrative status to a remote device if the remote device supports it, when used with send option.</p> |
| <code>storm-control</code> | <p>sets the storm control rate for broadcast, multicast, and DLF packets</p> <p>broadcast - Broadcast packets</p> <p>multicast - Multicast packets</p> <p>dlf - Unicast packets</p> <p>level - Storm-control suppression level as a total number of packets per second. Permissible values: 1-250,000</p> |
| <code>rate-limit output</code> | <p>rate-value - Line rate in kbps</p> <p>burst-value- Burst size value in kbps</p> |
| <code>clear interfaces [<interface-type> <interface-id>] counters</code> | clears all the current interface counters from the interface |

6.12.1 Port Configuration Example

1. Set a port speed to 100

```
iSG18GFP# config terminal
```

```
iSG18GFP(config)# interface fastethernet 0/2
```

```
iSG18GFP(config-if)# no negotiation
```

```
iSG18GFP(config-if)# speed 100
```

2. Set a port as Trunk. Make sure to remove it from any vlan at which it is set as untagged member.

```
iSG18GFP(config)# Vlan 1
```

```
iSG18GFP(config-vlan)# no ports fastethernet 0/1 untagged fastethernet 0/1
```

```
iSG18GFP(config-vlan)# exit
```

```
iSG18GFP(config)# interface fastethernet 0/1
```

```
iSG18GFP(config-if)# switchport mode trunk
```

```
iSG18GFP(config-if)# switchport acceptable-frame-type all
```

3. Set a port PVID

```
iSG18GFP(config)# interface fastethernet 0/5
```

```
iSG18GFP(config-if)# switchport pvid 5
```

4. Set a Port Alias

```
iSG18GFP(config)# interface fastethernet 0/2
```

```
iSG18GFP(config-if)# alias Office-network
```

6.12.2 Configuration Output Example

```
iSG18GFP# show interfaces fastethernet 0/2
```

```
Fa0/2 up, line protocol is up (connected)
```

```
Bridge Port Type: Customer Bridge Port
```

```
Interface SubType: fastEthernet
```

```
Interface Alias: Office-network
```

```
Hardware Address is 00:20:d2:fc:c1:f1
```

```
MTU 1500 bytes, Full duplex, 100 Mbps, No-Negotiation
```

```
HOL Block Prevention disabled.
```

```
CPU Controlled Learning disabled.
```

```
Auto-MDIX on
```

```
Input flow-control is off, output flow-control is off
```

```
Link Up/Down Trap is enabled
```

```
iSG18GFP# show interfaces status
```

| Port | Status | Duplex | Speed | Negotiation | Capability |
|-------|---------------|--------|-----------------|-----------------------|--------------|
| ----- | ----- | ----- | ----- | ----- | ----- |
| Fa0/1 | not connected | Half | - | Auto | Auto-MDIX on |
| Fa0/2 | connected | Full | 100 Mbps | No-Negotiation | Auto-MDIX on |
| Fa0/3 | not connected | Half | - | Auto | Auto-MDIX on |

```
...
```

```
iSG18GFP# show vlan port config port fastethernet 0/1
```

```
Vlan Port configuration table
```

```
-----  
Port Fa0/1
```

```
Bridge Port Type      : Customer Bridge Port
Port Vlan ID          : 1
Port Acceptable Frame Type : Admit All
Port Mac Learning Status : Enabled
Port Mac Learning Limit : Default
Port Ingress Filtering : Disabled
Port Mode              : Trunk
```

...

```
iSG18GFP# show vlan port config port fastethernet 0/5
```

Vlan Port configuration table

Port Fa0/5

```
Bridge Port Type      : Customer Bridge Port
Port Vlan ID          : 5
Port Acceptable Frame Type : Admit All
Port Mac Learning Status : Enabled
```

...

Login and Management

Configuring of the Login Authentication Method sets the authentication method.

Setting up specific authorized personnel to manage iSG18GFP is possible using filtering conditions such as IP address (mandatory), vlan-id, and service type (SSH, Telnet, SNMP, etc.), etc.

Once the information about the authorized personnel has been configured in the system, no other entity can have management privileges to the secure gateway over IP network. Serial console management remains available and is not influenced by the authorized manager conditions.

If no authorized managers are configured (default state), then secure gateway management is possible on all configured VLANs and associated ports via the respective IP interfaces assigned.

7.1 Login Authentication Hierarchy

GCE

+ root

- lock
- logout
- show authorized-manager [ip-source < ip_addr >]
- show system information
- show logging
- show users
- show aliases
- show line { console | vty <line> }
- listuser
- show privilege

+ configure terminal

- [no] authorized-manager ip-source <ip_addr> {<ip_mask> ,cpu0 <CR | service> interface <type>, service <type> ,vlan <port_list> }
- login authentication [{ radius | tacacs }] [local]
- login authentication default { default | <list-name> }
- login block-for <seconds (30-600) > attempts <tries (1-10) >
- username <user-name> { confirm-password, [0 | 7 | LINE], password [8-20 char], privilege <1-15> , status [enable | disable] }
- no username <user-name>

ACE

- user change password uname <string>
- user pwd-life-time [set-max] [set-warning]
- user show active-users

7.2 Login Authentication Commands Description

Table 15 – Login Authentication Commands Description

| Command | Description |
|------------------------------|---|
| | Under configure terminal (config) command |
| authorized-manager ip-source | Adds a specific authorized manager according to an IP source. [no] suffix in the beginning of the command will removes a specific authorized manager from the list of authorized managers. |
| <ip_addr> | Sets the network or host address from which the secure gateway is managed. An address 0.0.0.0 indicates 'Any Manager'. |
| <ip_mask> | Sets the subnet mask for the configured network or host address. The configured subnet mask should be in the same subnet of the network in which the secure gateway is placed. |
| interface | Configures the type of physical interface to be used by the authorized manager. The values can be: Fastethernet Gigabitethernet port-channel <port_list> |
| vlan <port_list> | Sets the list of VLANs or a single specific VLAN in which the authorized manager can reside. |
| Service | Configures the type of service to be used by the authorized manager. The values can be: http https snmp ssh telnet |
| | |

| Command | Description |
|---|---|
| login authentication [[radius tacacs]] [local] | <p>Radius: Sets the RADIUS server to be used as an authentication server. Enables remote access servers to communicate with a central server to authenticate dial-in users and authorize their access to the requested system or service.</p> <p>TACACS: Sets the TACACS server to be used as an authentication server. Communicates with the authentication server commonly used in networks.</p> <p>Local: Sets local authentication. The user identification, authentication, and authorization method are chosen by the local system administration and does not necessarily comply with any other profiles.</p> <p>Default: local</p> |
| default | <p>Default: Sets the default authentication method for User Logins.</p> |
| [no] username | <p>Set a new user.</p> <p>Username: 2-32 characters' length.</p> <ul style="list-style-type: none"> - Must start with A..Z or a..z - Allowed small and capital letters. - Allowed numbers: 0-9 - Allowed special symbols: - and _ <p>Password: 8-32 characters' length.</p> <ul style="list-style-type: none"> - Must include at least one small letter. - Must include at least one capital letter. - Must include at least one number or special symbol. - Allowed symbols: @#\$\$%^&*()-+./<`\` - Username is not allowed to be inside the password. - Swapped username is not allowed. - Three consecutive similar letters are not allowed. <p>Privilege: 1-15.</p> |
| show alias | Displays the aliases |

7.3 Password Commands Hierarchy

- + [configure terminal](#)
- [password max-life-time \[<days \(0-180\)>\]](#)
- [password validate char \[lowercase\] \[uppercase\] \[numbers\] \[symbols\]](#)
- [password warning-life-time \[<days \(0-14\)>\]](#)

7.4 Password Change Procedure (GCE/ACE)

When changing a GCE password:

1. In CLI root, go to configure terminal by typing [configure terminal](#).
2. Type [username <string> privilege \(1-15\)](#) [instead of <string> write the name of the username and set the privilege level according to the number, 1 for lowest and 15 for highest].

3. "Password:" line will appear.
4. Type the new password twice (the first one is for setup, the second is for verification)
5. In case of successful password change a message will be sent to syslog. Message will contain:
 - a. Changer's user name
 - b. User name of the applied password change

When changing an ACE password

1. In CLI root, go to ACE terminal by typing [application connect](#).
2. Type [user change password uname su](#).
3. "Old password:" line will appear.
4. Type old password first for authentication and then type the new password twice (the first one is for setup, the second is for verification)
5. In case of successful password change a message will be sent to syslog. Message will contain:
 - a. Changer's user name
 - b. User name of the applied password change.

7.5 Password Expiration

The password expiration has the following pre-set parameters:

- maximum time (default = 90 days)
- warning time (default = 10 days)

At the next login, the iSG18GFP will notify the user to change the password after the warning time has elapsed. A proper message will be sent to syslog.

After the password expiration ('maximum time' elapsed), the iSG18GFP will notify the user upon next login and enforce a change of the password. A proper message will be sent to syslog.

7.6 CLI / iDMS User and Password Protection

Login authentication attempts either through the CLI or [iEMSiDMS \(Industrial Device Management System\)](#) are limited to 3. After that the system will close the SSH server for one minute.

```
<129>Jul 31 10:57:59 iSG18GFP CLI Attempt to login as su via console failed
```

```
% Maximum Password tries over, User is blocked
```



Figure 7 - Error Message when Wrong Password Entered

In addition, on interfaces different than the console, after 9 attempts, the IP will be blocked. The IP can be unblocked once the user is logged in to the iSG18GFP through a different IP or through the console.

7.7 Examples

1. Changing the password of the su (*substitute user*, *super user*, *switch user*, or *set user*) that is used by a computer user to execute commands with the privileges of another user account user)

```
iSG18GFP(config)# username su password Eb12#$asd privilege 15
```

2. Configuring of users.

```
iSG18GFP(config)# username company-ceo password User#123 privilege 15
```

3. Example for assignment of an authorized manager.

```
iSG18GFP(config)# authorized-manager ip-source 10.10.20.20 / 32 interface fastethernet 0/1 vlan 1 service ssh snmp telnet
```

```
iSG18GFP(config)# authorized-manager ip-source 10.10.10.10
```

```
iSG18GFP# show authorized-managers
```

Ip Authorized Manager Table

```
-----
```

```
Ip Address      : 10.10.10.10
```

```
Ip Mask        : 255.255.255.255
```

```
Services allowed : SSH
```

```
Ports allowed  : Fa0/1, Fa0/2, Fa0/3, Fa0/4
```

```
                Fa0/5, Fa0/6, Fa0/7, Fa0/8
```

```
                Gi0/1, Gi0/2, Gi0/3, Gi0/4
```

```
                Fa0/9, Fa0/10, Fa0/11, Fa0/12
```

```
                Fa0/13
```

```
On cpu0        : Deny
```

```
Vlans allowed  : All Available Vlans
```

```
Ip Address      : 10.10.20.20
```

```
Ip Mask        : 255.255.255.255
```

```
Services allowed : SNMP, TELNET, SSH
```

```
Ports allowed  : Fa0/1
```

```
On cpu0        : Deny
```

```
Vlans allowed  : 1
```

4. An example for blocking management to VLAN 1.

```
config terminal
```

```
authorized-manager ip-source 0.0.0.1 / 32 vlan 1
```

7.8 Privilege Level

To allocate system accessibility to different users in the best way, privilege levels can be determined.

A total of 16 levels numbered from 0 to 15 can be configured. By default, the root user holds privilege level 15, allowing complete system availability. Privilege level 0 is the lowest level, restricting the user to minimum system access. A user with privilege level 0 can access only the following commands:

- Enable
- Disable
- Exit
- Help
- logout

Users with privilege level 1 can access all user-level commands with iSG18GFP> prompt.

The system allows to configure additional privilege levels (from level 2 to 14) to meet the needs of the users while protecting the system from unauthorized access.

Users with privilege level 15 can access all commands. It is the least restricted level.

7.8.1 Commands Description

Table 16 – Commands Description

| Command | Description |
|----------------------|---|
| VLAN Module status | Enable |
| Config | |
| Username <user-name> | Specifies the login user name to be created |
| Password <passwd> | Specifies the password to be entered by the user to login to the system. Password must contain 8-20 characters and should include at least one of each character type: * special character * alphabetic character * numerical character * uppercase character * lowercase character Special characters supported: !@#\$%^&* () {} [] \ ` ~ += |
| privilege <1-15> | Applies restriction to the user for accessing the CLI commands. These values range between 1 and 15. For example, a user ID configured with privilege level as four can access only the commands having privilege ID lesser than or equal to four |

7.9 Serial Console Port

Management over the serial console port is enabled by default but it can be blocked with the following command.

For the change in state to take effect the system must be rebooted.



Always maintain management over IP interface prior to disabling the console port.

7.9.1 Connecting to the Console Port

The console port is an EIA232 VT-100 compatible port for enabling the definition of the device's basic operational parameters.

7.9.1.1 Connecting the device to a PC using the Console Port:

1. Connect the RJ45 connector of the console cable to the device's Console Port (CON).
2. Connect the other side of the cable to the PC.
3. Configure the PC port to 9600-N-8-1 (9600 bps, no parity, 8 data bits, 1 stop bit, no flow control)

The following table details the console cable pin-out.

Table 17 – Commands Description

| Signal Name | RJ45 Male | DB9 Female |
|-------------|-----------|------------|
| - | 1 | - |
| Rx | 2 | 3 |
| Tx | 3 | 2 |
| GND | 4 | 5 |
| GND | 5 | 5 |
| - | 6 | - |
| - | 7 | - |
| - | 8 | - |

7.9.2 CLI Console Commands

These commands enable the console CLI through a serial port. The no form of the command disables the console CLI.

+ root

- lock

- logout

- [no] cli console

+ config

+ line {vty | console}

- exec-timeout <timeout sec>

- Show nvram



The "cli console" takes effect only after system restart.

7.10 Management

The switch can be managed via following methods:

- IP and VLAN based
- Serial console port
- Web management

For restrictions of users, privileges, and authentications, see the chapters in this manual such as Section 7.8 Privilege Level and Section 7 Login and Management.

7.10.1 Default state

Table 18 – Default State of Features

| Feature | Default state |
|-------------------|---|
| Vlan 1 | Active. All ports are members |
| Layer 3 interface | Interface VLAN 1 is set to 192.168.0.100 255.255.255.0/24 (as per 7.1-.4, paragraph 3). |
| SSH | Enabled |
| Telnet | Disabled |
| Http | Disabled |
| Console | Enabled |
| User | User name: su Password: 1234 Privilege: admin (15) |

7.10.2 Commands Hierarchy

- ```
+ root
- set host-name <[default | <name>]
- set switch-host-name { default | <string(15)> }
- set welcome-banner [default | <"banner name">]
- set ssh-client { enable | disable }
- set telnet-client { enable | disable }
- ssh {<user>@<remote IP>}
- show iss memory all
- show iss-memory-leak modules
- telnet [user]@{remote IP}
- lock
- logout
- show running-config system
```

- + **config terminal**
- + **line {vty | console}**
  - **exec-timeout <timeout sec>**
  - **[no] cli console**
  - **set cli pagination {on| off}**
  - **set cli terminal-line-count <integer (10-40)>**
  - **set cli terminal-line-length <integer (40-132)>**
  - **[no] feature telnet**
  - **set ip http [ enable | disable]**
  - **ip http port <port-number (1-65535)>**
- + **interface <type> <port id>**
  - **[no] switchport pvid <vlan ID>**
  - **[no] shutdown**
- + **[no] interface vlan <vlan id>**
  - **[no] shutdown**
- + **ip address [dhcp | <ip-address> <subnet-mask>]**
- **[no] ip http port <port>**
- **set ip http**
- + **Application connect**
- + **reload**
  - **schedule date-and-time YYYY-MM-DD,HH:MM:SS**
  - **schedule every <180 – 604800 seconds >**
  - **schedule time HH:MM:SS**
  - **schedule in <0 – 604800 seconds >**
  - **cancel**
  - **show**
  - **show ip interface**
  - **show http server status**



- show running-config interface vlan <vlan id>
- Show interfaces
- Show interfaces <type> <port id>
- show telnet server
- show vlan port config [port <type> <port id>]
- show running-config interface <type> <port id>
- show telnet-client
- show ssh-client

### 7.10.3 Commands Description

Table 19 – Commands Description

| Command                        | Description                                                                                                                                                                               |
|--------------------------------|-------------------------------------------------------------------------------------------------------------------------------------------------------------------------------------------|
| set host-name                  | Set the switch name as shown in the root prompt. Default name is "iSG18GFP". Spaces are not supported.                                                                                    |
| set switch-host-name           | Set the system host name and the SNMP name. configurable 15-character string. Special characters are supported except the symbol "!".                                                     |
| set welcome-banner             | Set the welcome banner as shown at log in screen. default is "Welcome Radiflow customer". If spaces are required, place the complete title in double brackets.                            |
| ssh                            | The switch supports SSH client allowing It to open SSH session to a remote partner.<br>User: user name to be logged in at the remote partner.<br>Remote-ip: IP address of remote partner. |
| Config terminal                |                                                                                                                                                                                           |
| line vty                       | Set idle time out for telnet / ssh to the switch.<br>exec-timeout: given in seconds<br>default: 300 seconds                                                                               |
| [no] cli                       | This command enables the console CLI through a serial port. The no form of the command disables console CLI.<br><br>This command takes effect only on system restart.                     |
| [no] ip http port <port>       | This command sets the HTTP port. This port is used to configure the router using the Web interface.<br>port number: 1-65535.<br><br>Default: 80                                           |
| set ip http {enable   disable} | Enable: Enables HTTP in the switch.<br>Disable: Disables HTTP in the switch<br><br>Default: enable                                                                                        |

| Command                                    | Description                                                                                                                                                                                                       |
|--------------------------------------------|-------------------------------------------------------------------------------------------------------------------------------------------------------------------------------------------------------------------|
| <code>[no] feature telnet</code>           | This command enables the telnet service in the system.                                                                                                                                                            |
| Application Connect                        |                                                                                                                                                                                                                   |
| <code>reload schedule date-and-time</code> | Set specific date and time for switch reload.<br>Time format: <code>YYYY-MM-DD,HH:MM:SS</code><br>configuration which was not committed will not be available after reloading!                                    |
| <code>reload schedule every</code>         | Set time interval for cyclic automatic system reload.<br>Permissible range in <code>seconds</code> is <code>180 – 604800</code> .<br>configuration which was not committed will not be available after reloading! |
| <code>reload schedule time</code>          | Set specific time for switch reload.<br>Time format: <code>HH:MM:SS</code><br>configuration which was not committed will not be available after reloading!                                                        |
| <code>reload schedule in</code>            | Set specific timer for next switch reload.<br>Permissible range in <code>seconds</code> is <code>180 – 604800</code> .<br>configuration which was not committed will not be available after reloading!            |
| <code>reload cancel</code>                 | Cancels all scheduled automatic reloads                                                                                                                                                                           |
| <code>reload show</code>                   | Shows user set scheduled reloads                                                                                                                                                                                  |

## 7.10.4 Example

For management of ports using designated VLAN and IP, follow the configuration example shown below.

1. Create your vlan and assign ports. **Port 0/1 is configured as untagged,0/2 as tagged.**

Config terminal

```
vlan 10

ports fastethernet 0/1-2 untagged fastethernet 0/1

exit
```

2. Enable the required ports

```
interface fastethernet 0/1

no shutdown

switchport pvid 10

map switch default

exit

interface fastethernet 0/2
```

```
no shutdown
switchport pvid 10
map switch default
exit
```

### 3. Create the IP interface to the vlan

```
interface vlan 10
shutdown
ip address 192.168.0.100 255.255.255.0
no shutdown
end
```

### 4. Create static route

```
Config terminal
ip route 0.0.0.0 0.0.0.0 192.168.0.1 1
end
write startup-cfg
```

## 7.11 System Alias

This command replaces the given token by the given string. The no form of the command removes the alias created for the given string. This is to allow easier names to be used for perhaps long cli command.

- + **Root**
- + **Config terminal**
  - **alias <replacement string> <token to be replaced>**
  - **show alias**

**Table 20 – Commands for Creating Alias**

| Command                | Description                                                    |
|------------------------|----------------------------------------------------------------|
| Config terminal        |                                                                |
| Alias                  |                                                                |
| <replacement string>   | Represents the string for which a replacement is needed.       |
| <token to be replaced> | Specifies an abbreviated/ short form of the replacement string |
| show alias             | Displays the aliases                                           |

## 7.12 CLI Pagination

Some show commands may produce a long output. By default, the output will be interrupted after every screen length pending with the note “—more—” to continue.

The options are:

- Press the ENTER key to advance the output by a single line.
- Press the SPACE key to advance the output by a screen length.
- Press the Q key will interrupt the output entirely.
- Turn CLI pagination on/off is available with the following commands:

```
iSG18GFP(config)# set cli pagination on
```

```
iSG18GFP(config)# set cli pagination off
```

An output example of a show command with pagination set to on:

```
iSG18GFP# show running-config
```

```
#Building configuration...
```

```
snmp trap syslog-server-status
```

```
!
```

```
no smtp authentication
```

```
!
```

```
!
```

```
queue 1 interface fastethernet 0/1 qtype 1 scheduler 1 weight 1 queue-type unicast
```

```
!
```

```
queue 3 interface fastethernet 0/1 qtype 1 scheduler 1 weight 1 priority 2 queue
```

```
-type unicast
```

```
!
```

```
--More--
```

## 7.13 MAC-Address Table (FDB)

### 7.13.1 Port Mac Learning Limit

The Administrator can enable or disable the Mac Learning Status of each port. By default, each port in the bridge is allocated a limit on the number of Mac addresses that is learnt on that port. The Mac Learning Limit on each port is configurable. The Mac Learning Limit is applicable only for the dynamically learnt entries.

## 7.13.2 Commands Hierarchy

+ root

+ config terminal

- set mac-learning { enable | disable }

- unicast-mac learning limit <100-16000>

- mac-address-table aging-time <sec (300,10-1000000)>

- mac-address-table static unicast <MAC> vlan <vlan id> interface <type> <id>

- no mac-address-table static unicast <MAC> vlan <vlan id>

+ interface <type> <port id>

- switchport unicast-mac learning [enable | disable]

- switchport unicast-mac learning limit <limit value(0-100)>

- switchport unicast-mac learning { enable | disable }

- switchport ingress-filter

- multicast-mac limit <limit>

- clear fdb

- show mac-address-table

- show vlan port config

- show multicast-mac limit

 For MAC traffic to be learned with a proper VLAN tag, ingress-filtering must be enabled on the interface. Otherwise, it will be learned at VLAN 1.

 IP traffic will be learned with the VLAN tag by default.

### 7.13.3 Configuration Example, Static MAC entry

1. Place a static entry

```
iSG18GFP(config)# mac-address-table static unicast 02:20:d2:fc:1c:95 vlan 1 interface fastethernet 0/4
```

```
iSG18GFP# show mac-address-table
```

Switch default

| Vlan | Mac Address       | Type   | ConnectionId | Ports |
|------|-------------------|--------|--------------|-------|
| 1    | 02:20:d2:fc:1c:95 | Static | Fa0/4        |       |
| 4092 | 02:20:d2:fc:1c:78 | Static | Gi0/3        |       |
| 4092 | 02:20:d2:fc:1c:79 | Static | Fa0/10       |       |
| 4092 | 02:20:d2:fc:1c:7a | Static | Fa0/11       |       |

-----

Total Mac Addresses displayed: 4

2. Remove a static entry

```
iSG18GFP(config)# no mac-address-table static unicast 02:20:d2:fc:1c:95 vlan 1
```

### 7.13.4 Example of Exceeding MAC Learning Limit at a port

1. Set MAC Learning Limit for an interface.

```
config
```

```
interface fastethernet 0/1
```

```
switchport unicast-mac learning limit value 5
```

```
end
```

Station MAC that exceeds the allowed limit will not be learned in the fdb table, and syslog message will indicate this as a warning.

```
iSG18GFP# show logging
```

```
<129>May 11 11:38:12 iSG18GFP CFA Mac learning limit exceeded on Port Fa 0/1 SRC MAC 54:53:ED:2B:19:86
```

## 7.14 IP ARP Table

The ARP (Address Resolution Protocol) cache timeout can be set in the system. Static entries are allowed to be entered.

### 7.14.1 Commands Hierarchy

+ root

+ config terminal

- arp timeout <seconds (7200,30-86400)>

- arp <ip address> <hardware address> Vlan <vlan-id(1-4094)>

- no arp <ip address>

- show ip arp [ { Vlan <vlan-id(1-4094)> | <interface-type> <interface-id> | <ip-address> | <mac-address> | summary | information } ]

**Table 21 – Commands Hierarchy**

| Commands Description           | Description                                                                                                                                                                                                                                                                                                                                                                                                                              |
|--------------------------------|------------------------------------------------------------------------------------------------------------------------------------------------------------------------------------------------------------------------------------------------------------------------------------------------------------------------------------------------------------------------------------------------------------------------------------------|
| Config terminal                |                                                                                                                                                                                                                                                                                                                                                                                                                                          |
| Arp timeout <>                 | sets the ARP (Address Resolution Protocol) cache timeout. The timeout defines the period an ARP entry remains in the cache. When a new timeout value is assigned, it only affects the new ARP entries. All the older entries retain their old timeout values. The timeout values can be assigned to dynamic ARP entries only. static ARP entries remain unaltered by timeout value.<br><br>timeout <seconds (30-86400)><br>default: 7200 |
| arp <ip address> <MAC> vlan <> |                                                                                                                                                                                                                                                                                                                                                                                                                                          |
|                                | <ip address>: The IP address or IP alias to map to the specified MAC address.                                                                                                                                                                                                                                                                                                                                                            |
|                                | <hardware address>: Defines the MAC address to map to the specified IP address or IP alias.                                                                                                                                                                                                                                                                                                                                              |
|                                | Vlan <vlan-id (1-4094)>                                                                                                                                                                                                                                                                                                                                                                                                                  |

## 7.14.2 Configuration Example

1. Set ARP timeout.

```
iSG18GFP# config terminal
```

```
iSG18GFP(config)# arp timeout 50
```

2. Set static entry.

```
iSG18GFP(config)# arp 172.18.212.100 00:11:22:33:44:55 Vlan 1
```

Output example

```
iSG18GFP# show ip arp
```

```
VRF Id : 0
```

```
VRF Name: default
```

```
Address Hardware Address Type Interface Mapping
```

```

```

```
172.18.212.100 00:11:22:33:44:55 ARPA vlan1 Static
```

```
iSG18GFP# show ip arp information
```

```
ARP Configurations:
```

```

```

```
VRF Name: default
```

```
Maximum number of ARP request retries is 3
```

**ARP cache timeout is 50 seconds**